



THREADING



E - THREADING

E - 640 | Inserts code key

E - 642 | How to choose Thread Turning - Example

E - 644 | THREADING INSERTS

E - 685 | SPARE PARTS

E - 686 | EXTERNAL TOOLHOLDRES CODE KEY

E - 687 | THREAD HOLDERS

E - 689 | BORING BARS CODE KEY

E - 690 | THREAD BORING BARS

E - 693 | TECHNICAL DATA



Partial Profile Example

16 ER A 55 PH6920

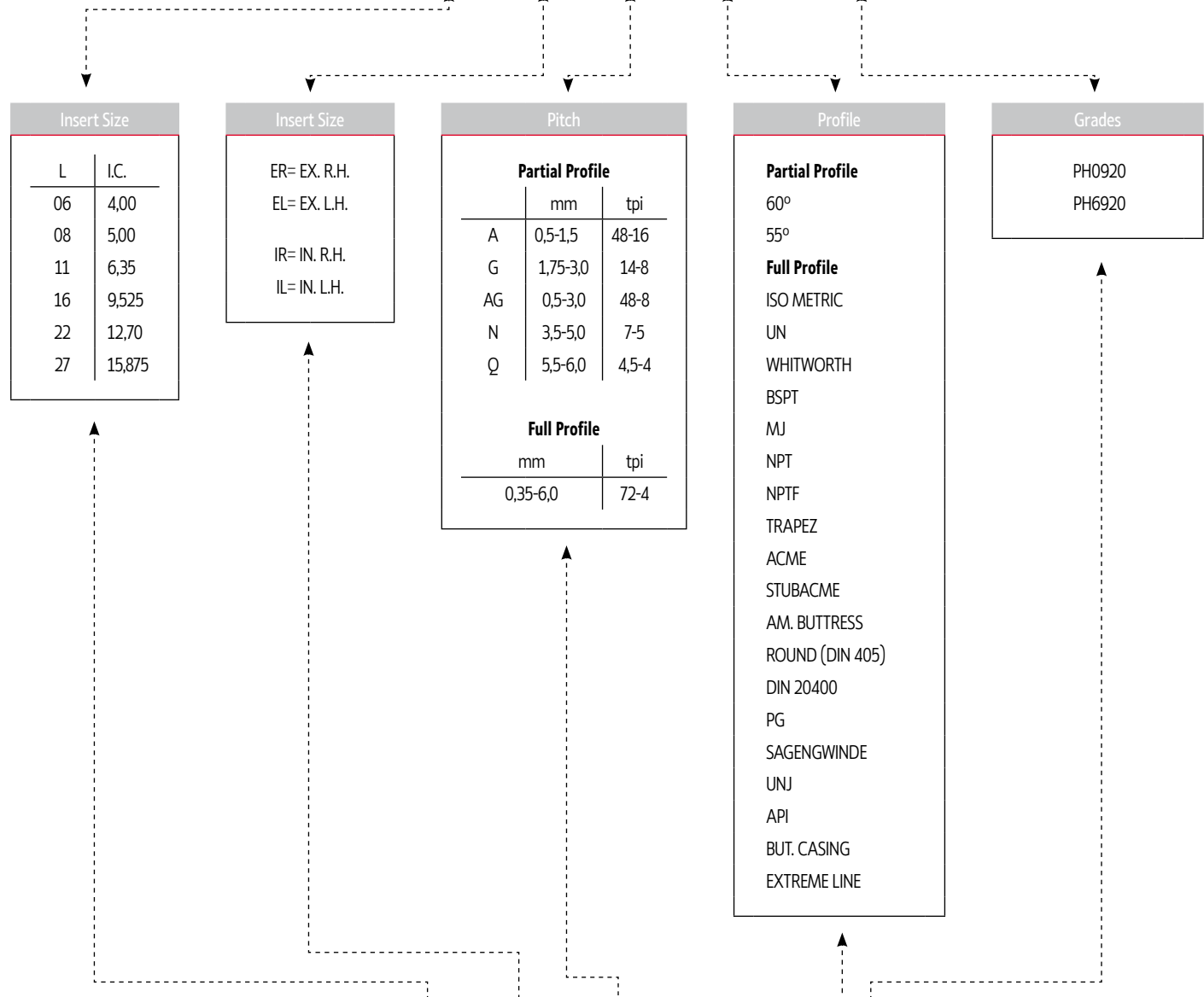

Full Profile Example

16 ER 1,5 ISO PH6920

Workpiece	Material Type	
	Material Dimension: Diameter and Length	
	Chipflow Character	
	Material Hardness	
Thread Application	External or Internal	
	Profile Shape	
	Surface Finish	
Machine	Machine Stability	
	Max. RPM	
	Clamping System Stability	
Coolant	Coolant Type	
Holders	Holder Cross Section Area	
	Holder Overhang	
	Through Coolant Option	
	Shank Type: Carbide, Alloy, Carbide Implant	
Partial Profile	Grade	
	Profile Shape: Pitch and Depth	
	Nose Radius	
	Chipbreaker Style	

HOW TO CHOOSE THREAD TURNING - EXAMPLE



Application:

Thread: External Right Hand
ISO Metric M40x2,5
Material: 4140 (25HRC)

1 - Choose the Thread Turning Method

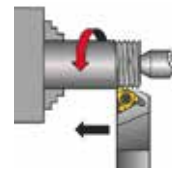

Feed direction towards the chuck was chosen.
Therefore, an external right hand insert and an external right hand holder will be used.

2 - Choose the Insert Size

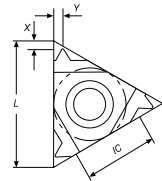

Chosen insert: **16ER 2.50ISO**

Insert Size	Pitch	Reference	Anvil	Toolholder
IC L mm	mm		RH	
9.525 16	2.50	16ER 2.50ISO	EA16	STCNL 2525 M16

3 - Choose the Toolholder



Chosen toolholder: **SXANR 2525 M16**

Insert Size	Reference	Dimensions mm		
IC		H=H1=B	F	L
9.525	SXANR 2525 M16	25	25	150

4 - Find the Helix Angle

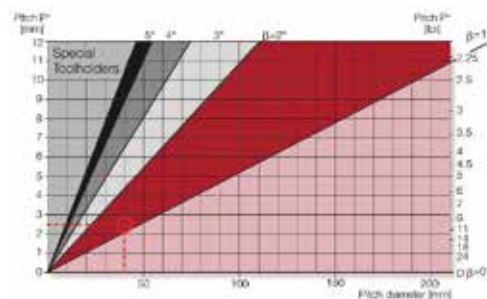

From the table, using a pitch of 2,5mm (10 tpi) and a workpiece diameter of 40mm (1,57"), we find the helix angle to be **1,5°**

5 - Choose the Correct Anvil

Anvil chosen: **EA16**

Insert Size		Holder				
IC	L mm	ER/IL	EA16+3.5	EA16+2.5	EA16	EA16+0.5
9.525	16					

6 - Choose the Carbide Grade and Cutting Speed

Carbide grade chosen: **PH6920**
Cutting Speed: **140 m/min**

Material:	Hardness Brinell HB		PH6920
	Non hardened	Hardened	
P Low alloy steel (alloying elements < 2%)	180	275	85-145
		350	75-140

7 - Determine the Number of Passes

Number of passes; 10

ISO External

Pitch mm	1.50	1.75	2.00	2.50	3.00	3.50	4.00
tpi	16	14	12	10	8	7	6
No. of passes	6-10	7-12	7-12	8-14	9-16	10-18	11-18

Summary

	Thread Type	ISO M40x2,5 External Right Hand
1	Feed Direction:	Towards the chuck
2	Insert and Grade:	16ER 2,5ISO PH6920
3	Toolholder:	SXANR 2525 M16
4	Helix Angle:	1,5°
5	Anvil:	EA16
6	Cutting Speed:	140 m/min
7	Number of Passes;	14

PARTIAL PROFILE 60°

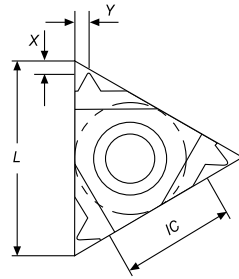
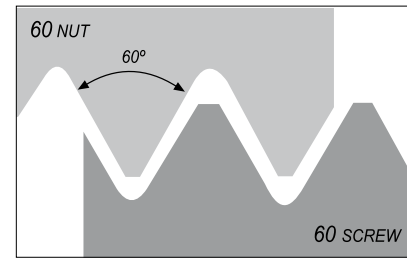

External

Order code Código (1)	Reference Referência Referencia	Pitch		Dimensions Dimensões Dimensiones (mm)				Stock - Grade Code (2)	
		MM	TPI	IC	L	X	Y	(68) PH6920	(D0) PH8920
1880592	11 ER A60	0.5-1.5	48-16	6.35	11	0.8	0.9	☉	○
1880429	16 ER A60	0.5-1.5	48-16	9.525	16	0.8	0.9	☉	○
1880431	16 ER G60	1.75-3.0	14-8	9.525	16	1.2	1.7	☉	○
1880388	16 ER AG60	0.5-3.0	48-8	9.525	16	1.2	1.7	☉	○
1880046	22 ER N60	3.5-5.0	7-5	12.70	22	1.7	2.5	☉	○
1882486	27 ER Q60	5.5-6.0	4.5-4	15.875	27	2.1	3.1	○	○
1881851	11 EL A60	0.5-1.5	48-16	6.35	11	0.8	0.9	○	○
1880771	16 EL A60	0.5-1.5	48-16	9.525	16	0.8	0.9	○	○
1880773	16 EL G60	1.75-3.0	14-8	9.525	16	1.2	1.7	○	○
1880524	16 EL AG60	0.5-3.0	48-8	9.525	16	1.2	1.7	○	○
1880853	22 EL N60	3.5-5.0	7-5	12.70	22	1.7	2.5	○	○
1882155	27 EL Q60	5.5-6.0	4.5-4	15.875	27	2.1	3.1	○	○

☉ Stock item | Produto de stock | Itens de stock

○ Available under request | Disponível sobre consulta | Disponible bajo consulta

Note: Order Code = (1) + (2)
See page E - 694 for more detail information

PARTIAL PROFILE 55°

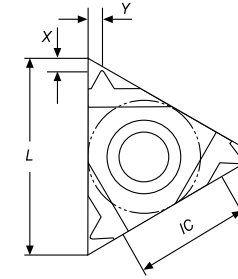
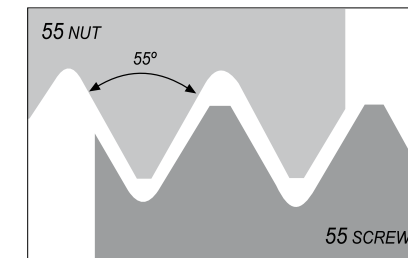
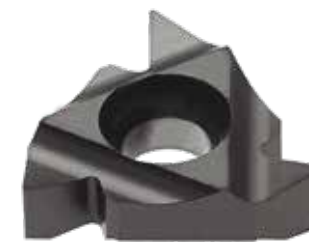

External

Order code Código (1)	Reference Referência Referencia	Pitch		Dimensions Dimensões Dimensiones (mm)				Stock - Grade Code (2)	
		MM	TPI	IC	L	X	Y	(68) PH6920	(D0) PH8920
1880598	11 ER A55	0.5-1.5	48-16	6.35	11	0.8	0.9	☉	○
1880430	16 ER A55	0.5-1.5	48-16	9.525	16	0.8	0.9	☉	○
1880432	16 ER G55	1.75-3.0	14-8	9.525	16	1.2	1.7	☉	○
1880433	16 ER AG55	0.5-3.0	48-8	9.525	16	1.2	1.7	☉	○
1880770	22 ER N55	3.5-5.0	7-5	12.70	22	1.7	2.5	☉	○
1882167	27 ER Q55	5.5-6.0	4.5-4	15.875	27	2.0	2.9	○	○
1881850	11 EL A55	0.5-1.5	48-16	6.35	11	0.8	0.9	○	○
1880776	16 EL A55	0.5-1.5	48-16	9.525	16	0.8	0.9	○	○
1880778	16 EL G55	1.75-3.0	14-8	9.525	16	1.2	1.7	○	○
1880780	16 EL AG55	0.5-3.0	48-8	9.525	16	1.2	1.7	○	○
1880858	22 EL N55	3.5-5.0	7-5	12.70	22	1.7	2.5	○	○
1882154	27 EL Q55	5.5-6.0	4.5-4	15.875	27	2.0	2.9	○	○

☉ Stock item | Produto de stock | Itens de stock

○ Available under request | Disponível sobre consulta | Disponible bajo consulta

Note: Order Code = (1) + (2)
See page E - 694 for more detail information

Internal

Order code Código (1)	Reference Referência Referencia	Pitch		Dimensions Dimensões Dimensiones (mm)				Stock - Grade Code (2)	
		MM	TPI	IC	L	X	Y	(68) PH6920	(D0) PH8920
1881730	06 IR A60	0.5-1.25	48-20	4.00	06	0.6	0.6	○	○
1881773	08 IR A60	0.5-1.5	48-16	5.00	08	0.6	0.7	○	○
1880595	11 IR A60	0.5-1.5	48-16	6.35	11	0.8	0.9	☉	○
1880045	16 IR A60	0.5-1.5	48-16	9.525	16	0.8	0.9	☉	○
1880435	16 IR G60	1.75-3.0	14-8	9.525	16	1.2	1.7	☉	○
1880437	16 IR AG60	0.5-3.0	48-8	9.525	16	1.2	1.7	☉	○
1880769	22 IR N60	3.5-5.0	7-5	12.70	22	1.7	2.5	☉	○
1882487	27 IR Q60	5.5-6.0	4.5-4	15.875	27	2.1	3.1	○	○
1881716	06 IL A60	0.5-1.25	48-20	4.00	06	0.6	0.6	○	○
1882199	08 IL A60	0.5-1.5	48-16	5.00	08	0.6	0.7	○	○
1880855	11 IL A60	0.5-1.5	48-16	6.35	11	0.8	0.9	○	○
1880772	16 IL A60	0.5-1.5	48-16	9.525	16	0.8	0.9	○	○
1880774	16 IL G60	1.75-3.0	14-8	9.525	16	1.2	1.7	○	○
1880775	16 IL AG60	0.5-3.0	48-8	9.525	16	1.2	1.7	○	○
1880854	22 IL N60	3.5-5.0	7-5	12.70	22	1.7	2.5	○	○
1882179	27 IL Q60	5.5-6.0	4.5-4	15.875	27	2.1	3.1	○	○

☉ Stock item | Produto de stock | Itens de stock

○ Available under request | Disponível sobre consulta | Disponible bajo consulta

Note: Order Code = (1) + (2)
See page E - 694 for more detail information

Internal

Order code Código (1)	Reference Referência Referencia	Pitch		Dimensions Dimensões Dimensiones (mm)				Stock - Grade Code (2)	
		MM	TPI	IC	L	X	Y	(68) PH6920	(D0) PH8920
1881729	06 IR A55	0.5-1.25	48-20	4.00	06	0.5	0.6	○	○
1881772	08 IR A55	0.5-1.5	48-16	5.00	08	0.6	0.7	○	○
1880006	11 IR A55	0.5-1.5	48-16	6.35	11	0.8	0.9	☉	○
1880434	16 IR A55	0.5-1.5	48-16	9.525	16	0.8	0.9	☉	○
1880436	16 IR G55	1.75-3.0	14-8	9.525	16	1.2	1.7	☉	○
1880438	16 IR AG55	0.5-3.0	48-8	9.525	16	1.2	1.7	☉	○
1880047	22 IR N55	3.5-5.0	7-5	12.70	22	1.7	2.5	☉	○
1882189	27 IR Q55	5.5-6.0	4.5-4	15.875	27	2.0	2.9	○	○
1881715	06 IL A55	0.5-1.25	48-20	4.00	06	0.5	0.6	○	○
1881751	08 IL A55	0.5-1.5	48-16	5.00	08	0.6	0.7	○	○
1880856	11 IL A55	0.5-1.5	48-16	6.35	11	0.8	0.9	○	○
1880777	16 IL A55	0.5-1.5	48-16	9.525	16	0.8	0.9	○	○
1880779	16 IL G55	1.75-3.0	14-8	9.525	16	1.2	1.7	○	○
1880781	16 IL AG55	0.5-3.0	48-8	9.525	16	1.2	1.7	○	○
1880857	22 IL N55	3.5-5.0	7-5	12.70	22	1.7	2.5	○	○
1882178	27 IL Q55	5.5-6.0	4.5-4	15.875	27	2.0	2.9	○	○

☉ Stock item | Produto de stock | Itens de stock

○ Available under request | Disponível sobre consulta | Disponible bajo consulta

Note: Order Code = (1) + (2)
See page E - 694 for more detail information

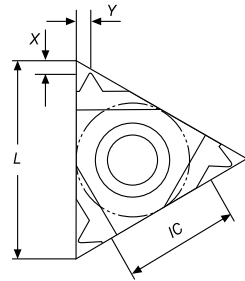
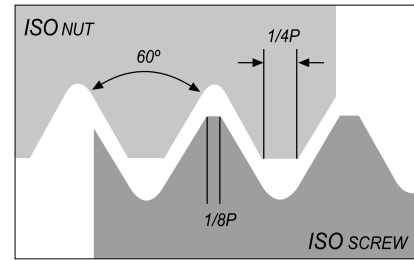
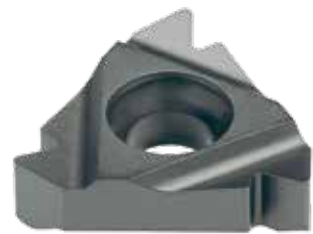

External

Geometry code (1) Código	Reference Referência Referencia	Pitch MM	Dimensions Dimensões Dimensiones (mm)				Stock - Grade Code (2)	
			IC	L	X	Y	(68) PH6920	(D0) PH8920
1881852	11 ER 0.35 ISO	0.35	6.35	11	0.8	0.4	○	○
1881853	11 ER 0.40 ISO	0.40	6.35	11	0.7	0.4	○	○
1881854	11 ER 0.45 ISO	0.45	6.35	11	0.7	0.4	○	○
1881855	11 ER 0.50 ISO	0.50	6.35	11	0.6	0.6	○	○
1881856	11 ER 0.60 ISO	0.60	6.35	11	0.6	0.6	○	○
1881857	11 ER 0.70 ISO	0.70	6.35	11	0.6	0.6	○	○
1881858	11 ER 0.75 ISO	0.75	6.35	11	0.6	0.6	⊗	○
1881859	11 ER 0.80 ISO	0.80	6.35	11	0.6	0.6	○	○
1880602	11 ER 1.00 ISO	1.00	6.35	11	0.7	0.7	⊗	○
1881861	11 ER 1.25 ISO	1.25	6.35	11	0.8	0.9	⊗	○
1880603	11 ER 1.50 ISO	1.50	6.35	11	0.8	1.0	⊗	○
1881864	11 ER 1.75 ISO	1.75	6.35	11	0.8	1.1	○	○
1881881	11 ER 2.00 ISO	2.00	6.35	11	0.8	1.1	○	○
1882030	16 ER 0.35 ISO	0.35	9.525	16	0.8	0.4	○	○
1882031	16 ER 0.40 ISO	0.40	9.525	16	0.7	0.4	○	○
1882032	16 ER 0.45 ISO	0.45	9.525	16	0.7	0.4	○	○
1880819	16 ER 0.50 ISO	0.50	9.525	16	0.6	0.6	○	○
1882033	16 ER 0.60 ISO	0.60	9.525	16	0.6	0.6	○	○
1882034	16 ER 0.70 ISO	0.70	9.525	16	0.6	0.6	○	○
1880447	16 ER 0.75 ISO	0.75	9.525	16	0.6	0.6	⊗	○
1880804	16 ER 0.80 ISO	0.80	9.525	16	0.6	0.6	○	○
1880479	16 ER 1.00 ISO	1.00	9.525	16	0.7	0.7	⊗	○
1880007	16 ER 1.25 ISO	1.25	9.525	16	0.8	0.9	⊗	○
1880262	16 ER 1.50 ISO	1.50	9.525	16	0.8	1.0	⊗	○
1880732	16 ER 1.75 ISO	1.75	9.525	16	0.9	1.2	⊗	○
1880018	16 ER 2.00 ISO	2.00	9.525	16	1.0	1.3	⊗	○
1880020	16 ER 2.50 ISO	2.50	9.525	16	1.1	1.5	⊗	○
1880022	16 ER 3.00 ISO	3.00	9.525	16	1.2	1.6	⊗	○
1883740	16 ER 3.50 ISO	3.50	9.525	16	1.2	1.7	○	○
1880823	22 ER 3.50 ISO	3.50	12.70	22	1.6	2.3	⊗	○
1880811	22 ER 4.00 ISO	4.00	12.70	22	1.6	2.3	⊗	○
1880824	22 ER 4.50 ISO	4.50	12.70	22	1.7	2.4	⊗	○
1880649	22 ER 5.00 ISO	5.00	12.70	22	1.7	2.5	⊗	○
1883741	22 ER 5.50 ISO	5.50	12.70	22	1.7	2.6	○	○
1883742	22 ER 6.00 ISO	6.00	12.70	22	1.9	2.7	○	○
1882163	27 ER 5.50 ISO	5.50	15.875	27	1.6	2.3	○	○
1882164	27 ER 6.00 ISO	6.00	15.875	27	1.8	2.5	○	○

⊗ Stock item | Produto de stock | Itens de stock ○ Available under request | Disponível sobre consulta | Disponible bajo consulta

Note: Order Code = (1) + (2)
See page E - 694 for more detail information

External

Geometry code (1) Código	Reference Referência Referencia	Pitch MM	Dimensions Dimensões Dimensiones (mm)				Stock - Grade Code (2)	
			IC	L	X	Y	(68) PH6920	(D0) PH8920
1881794	11 EL 0.35 ISO	0.35	6.35	11	0.8	0.4	○	○
1881795	11 EL 0.40 ISO	0.40	6.35	11	0.7	0.4	○	○
1881796	11 EL 0.45 ISO	0.45	6.35	11	0.7	0.4	○	○
1881797	11 EL 0.50 ISO	0.50	6.35	11	0.6	0.6	○	○
1881798	11 EL 0.60 ISO	0.60	6.35	11	0.6	0.6	○	○
1881799	11 EL 0.70 ISO	0.70	6.35	11	0.6	0.6	○	○
1881800	11 EL 0.75 ISO	0.75	6.35	11	0.6	0.6	○	○
1881801	11 EL 0.80 ISO	0.80	6.35	11	0.6	0.6	○	○
1881802	11 EL 1.00 ISO	1.00	6.35	11	0.7	0.7	○	○
1881803	11 EL 1.25 ISO	1.25	6.35	11	0.8	0.9	○	○
1881804	11 EL 1.50 ISO	1.50	6.35	11	0.8	1.0	○	○
1881806	11 EL 1.75 ISO	1.75	6.35	11	0.8	1.1	○	○
1880654	11 EL 2.00 ISO	2.00	6.35	11	0.8	1.1	○	○
1881977	16 EL 0.35 ISO	0.35	9.525	16	0.8	0.4	○	○
1881978	16 EL 0.40 ISO	0.40	9.525	16	0.7	0.4	○	○
1881979	16 EL 0.45 ISO	0.45	9.525	16	0.7	0.4	○	○
1881980	16 EL 0.50 ISO	0.50	9.525	16	0.6	0.6	○	○
1881981	16 EL 0.60 ISO	0.60	9.525	16	0.6	0.6	○	○
1881982	16 EL 0.70 ISO	0.70	9.525	16	0.6	0.6	○	○
1881983	16 EL 0.75 ISO	0.75	9.525	16	0.6	0.6	⊗	○
1881984	16 EL 0.80 ISO	0.80	9.525	16	0.6	0.6	○	○
1880782	16 EL 1.00 ISO	1.00	9.525	16	0.7	0.7	⊗	○
1880651	16 EL 1.25 ISO	1.25	9.525	16	0.8	0.9	⊗	○
1880652	16 EL 1.50 ISO	1.50	9.525	16	0.8	1.0	○	○
1880653	16 EL 1.75 ISO	1.75	9.525	16	0.9	1.2	⊗	○
1882519	16 EL 2.00 ISO	2.00	9.525	16	1.0	1.3	⊗	○
1880788	16 EL 2.50 ISO	2.50	9.525	16	1.1	1.5	⊗	○
1880488	16 EL 3.00 ISO	3.00	9.525	16	1.2	1.6	○	○
1883743	16 EL 3.50 ISO	3.50	9.525	16	1.2	1.7	○	○
1880844	22 EL 3.50 ISO	3.50	12.70	22	1.6	2.3	○	○
1880845	22 EL 4.00 ISO	4.00	12.70	22	1.6	2.3	○	○
1880846	22 EL 4.50 ISO	4.50	12.70	22	1.7	2.4	○	○
1880847	22 EL 5.00 ISO	5.00	12.70	22	1.7	2.5	○	○
1883744	22 EL 5.50 ISO	5.50	12.70	22	1.7	2.6	○	○
1883745	22 EL 6.00 ISO	6.00	12.70	22	1.9	2.7	○	○
1882150	27 EL 5.50 ISO	5.50	15.875	27	1.6	2.3	○	○
1882151	27 EL 6.00 ISO	6.00	15.875	27	1.8	2.5	○	○

⊗ Stock item | Produto de stock | Itens de stock ○ Available under request | Disponível sobre consulta | Disponible bajo consulta

Note: Order Code = (1) + (2)
See page E - 694 for more detail information

ISO METRIC ISO 965-1: 1999-11 | DIN 13: 2005-08

Internal

Geometry code (1) Código	Reference Referência Referencia	Pitch	Dimensions Dimensões Dimensiones (mm)				Stock - Grade Code (2)	
		MM	IC	L	X	Y	(68) PH6920	(D0) PH8920
1881717	06 IR 0.50 ISO	0.50	4.00	06	0.9	0.5	○	○
1881718	06 IR 0.75 ISO	0.75	4.00	06	0.8	0.5	○	○
1881719	06 IR 1.00 ISO	1.00	4.00	06	0.7	0.6	○	○
1881720	06 IR 1.25 ISO	1.25	4.00	06	0.6	0.6	○	○
1881752	08 IR 0.35 ISO	0.35	5.00	08	0.7	0.4	○	○
1881753	08 IR 0.50 ISO	0.50	5.00	08	0.6	0.5	○	○
1881754	08 IR 0.75 ISO	0.75	5.00	08	0.6	0.5	○	○
1881755	08 IR 1.00 ISO	1.00	5.00	08	0.6	0.6	○	○
1881756	08 IR 1.25 ISO	1.25	5.00	08	0.6	0.7	○	○
1881757	08 IR 1.50 ISO	1.50	5.00	08	0.6	0.7	○	○
1881758	08 IR 1.75 ISO	1.75	5.00	08	0.6	0.8	○	○
1881937	11 IR 0.35 ISO	0.35	6.35	11	0.8	0.3	○	○
1881938	11 IR 0.40 ISO	0.40	6.35	11	0.8	0.4	○	○
1881939	11 IR 0.45 ISO	0.45	6.35	11	0.8	0.4	○	○
1880825	11 IR 0.50 ISO	0.50	6.35	11	0.6	0.6	○	○
1881940	11 IR 0.60 ISO	0.60	6.35	11	0.6	0.6	○	○
1881941	11 IR 0.70 ISO	0.70	6.35	11	0.6	0.6	○	○
1880762	11 IR 0.75 ISO	0.75	6.35	11	0.6	0.6	⊗	○
1881942	11 IR 0.80 ISO	0.80	6.35	11	0.6	0.6	○	○
1880604	11 IR 1.00 ISO	1.00	6.35	11	0.8	0.7	⊗	○
1880827	11 IR 1.25 ISO	1.25	6.35	11	0.8	0.8	⊗	○
1880605	11 IR 1.50 ISO	1.50	6.35	11	0.8	1.0	⊗	○
1880828	11 IR 1.75 ISO	1.75	6.35	11	0.8	1.1	⊗	○
1880829	11 IR 2.00 ISO	2.00	6.35	11	0.8	0.9	⊗	○
1883746	11 IR 2.50 ISO	2.50	6.35	11	0.8	1.2	○	○
1882108	16 IR 0.35 ISO	0.35	9.525	16	0.8	0.3	○	○
1882109	16 IR 0.40 ISO	0.40	9.525	16	0.8	0.4	○	○
1882110	16 IR 0.45 ISO	0.45	9.525	16	0.8	0.4	○	○
1880830	16 IR 0.50 ISO	0.50	9.525	16	0.6	0.6	○	○
1882112	16 IR 0.60 ISO	0.60	9.525	16	0.6	0.6	○	○
1882113	16 IR 0.70 ISO	0.70	9.525	16	0.6	0.6	○	○
1880831	16 IR 0.75 ISO	0.75	9.525	16	0.6	0.6	○	○
1880832	16 IR 0.80 ISO	0.80	9.525	16	0.6	0.6	○	○
1880025	16 IR 1.00 ISO	1.00	9.525	16	0.6	0.7	⊗	○
1880026	16 IR 1.25 ISO	1.25	9.525	16	0.8	0.9	⊗	○
1880619	16 IR 1.50 ISO	1.50	9.525	16	0.8	1.0	⊗	○
1880733	16 IR 1.75 ISO	1.75	9.525	16	0.9	1.2	⊗	○
1880039	16 IR 2.00 ISO	2.00	9.525	16	1.0	1.3	⊗	○
1880041	16 IR 2.50 ISO	2.50	9.525	16	1.1	1.5	⊗	○
1880042	16 IR 3.00 ISO	3.00	9.525	16	1.1	1.5	⊗	○
1883747	16 IR 3.50 ISO	3.50	9.525	16	1.2	1.7	○	○
1880834	22 IR 3.50 ISO	3.50	12.70	22	1.6	2.3	⊗	○
1880818	22 IR 4.00 ISO	4.00	12.70	22	1.6	2.3	⊗	○
1880835	22 IR 4.50 ISO	4.50	12.70	22	1.6	2.4	○	○
1880650	22 IR 5.00 ISO	5.00	12.70	22	1.6	2.3	⊗	○
1883748	22 IR 5.50 ISO	5.50	12.70	22	1.6	2.3	○	○
1883749	22 IR 6.00 ISO	6.00	12.70	22	1.6	2.4	○	○
1882185	27 IR 5.50 ISO	5.50	15.875	27	1.6	2.3	○	○
1882186	27 IR 6.00 ISO	6.00	15.875	27	1.8	2.5	○	○

⊗ Stock item | Produto de stock | Itens de stock

○ Available under request | Disponível sobre consulta | Disponible bajo consulta

Note: Order Code = (1) + (2)
See page E - 694 for more detail information

Internal

Geometry code (1) Código	Reference Referência Referencia	Pitch	Dimensions Dimensões Dimensiones (mm)				Stock - Grade Code (2)	
		MM	IC	L	X	Y	(68) PH6920	(D0) PH8920
1881703	06 IL 0.50 ISO	0.50	4.00	06	0.9	0.5	○	○
1881704	06 IL 0.75 ISO	0.75	4.00	06	0.8	0.5	○	○
1881705	06 IL 1.00 ISO	1.00	4.00	06	0.7	0.6	○	○
1881706	06 IL 1.25 ISO	1.25	4.00	06	0.6	0.6	○	○
1881732	08 IL 0.50 ISO	0.50	5.00	08	0.6	0.5	○	○
1881733	08 IL 0.75 ISO	0.75	5.00	08	0.6	0.5	○	○
1881734	08 IL 1.00 ISO	1.00	5.00	08	0.6	0.6	○	○
1881735	08 IL 1.25 ISO	1.25	5.00	08	0.6	0.7	○	○
1881736	08 IL 1.50 ISO	1.50	5.00	08	0.6	0.7	○	○
1881737	08 IL 1.75 ISO	1.75	5.00	08	0.6	0.8	○	○
1881911	11 IL 0.35 ISO	0.35	6.35	11	0.8	0.3	○	○
1881912	11 IL 0.40 ISO	0.40	6.35	11	0.8	0.4	○	○
1881913	11 IL 0.45 ISO	0.45	6.35	11	0.8	0.4	○	○
1880837	11 IL 0.50 ISO	0.50	6.35	11	0.6	0.6	○	○
1881914	11 IL 0.60 ISO	0.60	6.35	11	0.6	0.6	○	○
1881915	11 IL 0.70 ISO	0.70	6.35	11	0.6	0.6	○	○
1880838	11 IL 0.75 ISO	0.75	6.35	11	0.6	0.6	○	○
1881916	11 IL 0.80 ISO	0.80	6.35	11	0.6	0.6	○	○
1880839	11 IL 1.00 ISO	1.00	6.35	11	0.8	0.7	○	○
1880840	11 IL 1.25 ISO	1.25	6.35	11	0.8	0.8	○	○
1880841	11 IL 1.50 ISO	1.50	6.35	11	0.8	1.0	○	○
1880842	11 IL 1.75 ISO	1.75	6.35	11	0.8	1.1	○	○
1880843	11 IL 2.00 ISO	2.00	6.35	11	0.8	0.9	⊗	○
1883750	11 IL 2.50 ISO	2.50	6.35	11	0.8	1.2	○	○
1882058	16 IL 0.35 ISO	0.35	9.525	16	0.8	0.3	○	○
1882059	16 IL 0.40 ISO	0.40	9.525	16	0.8	0.4	○	○
1882060	16 IL 0.45 ISO	0.45	9.525	16	0.8	0.4	○	○
1882061	16 IL 0.50 ISO	0.50	9.525	16	0.6	0.6	○	○
1882062	16 IL 0.60 ISO	0.60	9.525	16	0.6	0.6	○	○
1882063	16 IL 0.70 ISO	0.70	9.525	16	0.6	0.6	○	○
1882064	16 IL 0.75 ISO	0.75	9.525	16	0.6	0.6	○	○
1882065	16 IL 0.80 ISO	0.80	9.525	16	0.6	0.6	○	○
1880783	16 IL 1.00 ISO	1.00	9.525	16	0.6	0.7	⊗	○
1880784	16 IL 1.25 ISO	1.25	9.525	16	0.8	0.9	⊗	○
1880785	16 IL 1.50 ISO	1.50	9.525	16	0.8	1.0	⊗	○
1880786	16 IL 1.75 ISO	1.75	9.525	16	0.9	1.2	⊗	○
1880787	16 IL 2.00 ISO	2.00	9.525	16	1.0	1.3	⊗	○
1880789	16 IL 2.50 ISO	2.50	9.525	16	1.1	1.5	⊗	○
1880790	16 IL 3.00 ISO	3.00	9.525	16	1.1	1.5	⊗	○
1883751	16 IL 3.50 ISO	3.50	9.525	16	1.2	1.7	○	○
1880848	22 IL 3.50 ISO	3.50	12.70	22	1.6	2.3	○	○
1880849	22 IL 4.00 ISO	4.00	12.70	22	1.6	2.3	○	○
1880850	22 IL 4.50 ISO	4.50	12.70	22	1.6	2.4	○	○
1880851	22 IL 5.00 ISO	5.00	12.70	22	1.6	2.3	○	○
1883752	22 IL 5.50 ISO	5.50	12.70	22	1.6	2.3	○	○
1883753	22 IL 6.00 ISO	6.00	12.70	22	1.6	2.4	○	○
1882174	27 IL 5.50 ISO	5.50	15.875	27	1.6	2.3	○	○
1882175	27 IL 6.00 ISO	6.00	15.875	27	1.8	2.5	○	○

⊗ Stock item | Produto de stock | Itens de stock

○ Available under request | Disponível sobre consulta | Disponible bajo consulta

Note: Order Code = (1) + (2)
See page E - 694 for more detail information

AMERICAN UN (UNC, UNF, UNEF) | ANSI B1.1-1982

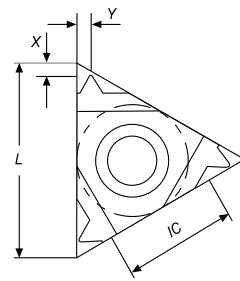
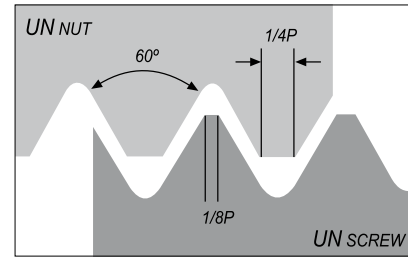
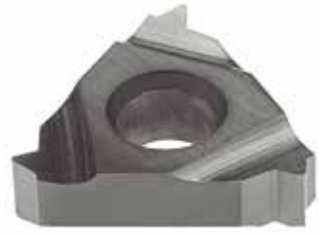

External

Geometry code (1) Código	Reference Referência Referencia	Pitch MM	Dimensions Dimensões Dimensiones (mm)				Stock - Grade Code (2)	
			IC	L	X	Y	(68) PH6920	(D0) PH8920
1881907	11 ER 72 UN	72	6.35	11	0.8	0.4	○	○
1881906	11 ER 64 UN	64	6.35	11	0.8	0.4	○	○
1881903	11 ER 56 UN	56	6.35	11	0.7	0.4	○	○
1881901	11 ER 48 UN	48	6.35	11	0.6	0.6	○	○
1881900	11 ER 44 UN	44	6.35	11	0.6	0.6	○	○
1881898	11 ER 40 UN	40	6.35	11	0.6	0.6	○	○
1881896	11 ER 36 UN	36	6.35	11	0.6	0.6	○	○
1881894	11 ER 32 UN	32	6.35	11	0.6	0.6	○	○
1881892	11 ER 28 UN	28	6.35	11	0.6	0.7	○	○
1881890	11 ER 27 UN	27	6.35	11	0.7	0.8	○	○
1881885	11 ER 24 UN	24	6.35	11	0.7	0.8	○	○
1881882	11 ER 20 UN	20	6.35	11	0.8	0.9	○	○
1881877	11 ER 18 UN	18	6.35	11	0.8	1.0	○	○
1881873	11 ER 16 UN	16	6.35	11	0.9	1.1	○	○
1881869	11 ER 14 UN	14	6.35	11	0.9	1.1	○	○
1882055	16 ER 72 UN	72	9.525	16	0.8	0.3	○	○
1882054	16 ER 64 UN	64	9.525	16	0.8	0.4	○	○
1882051	16 ER 56 UN	56	9.525	16	0.7	0.4	○	○
1882049	16 ER 48 UN	48	9.525	16	0.6	0.6	○	○
1882048	16 ER 44 UN	44	9.525	16	0.6	0.6	○	○
1882046	16 ER 40 UN	40	9.525	16	0.6	0.6	○	○
1882044	16 ER 36 UN	36	9.525	16	0.6	0.6	○	○
1880870	16 ER 32 UN	32	9.525	16	0.6	0.6	○	○
1880869	16 ER 28 UN	28	9.525	16	0.6	0.7	○	○
1882041	16 ER 27 UN	27	9.525	16	0.7	0.8	○	○
1880868	16 ER 24 UN	24	9.525	16	0.7	0.8	○	○
1880021	16 ER 20 UN	20	9.525	16	0.8	0.9	○	○
1880867	16 ER 18 UN	18	9.525	16	0.8	1.0	○	○
1880616	16 ER 16 UN	16	9.525	16	0.9	1.1	⊗	○
1880014	16 ER 14 UN	14	9.525	16	1.0	1.2	⊗	○
1880866	16 ER 13 UN	13	9.525	16	1.0	1.3	⊗	○
1880865	16 ER 12 UN	12	9.525	16	1.1	1.4	○	○
1883754	16 ER 11.5 UN	11.5	9.525	16	1.1	1.5	○	○
1880864	16 ER 11 UN	11	9.525	16	1.1	1.5	○	○
1880863	16 ER 10 UN	10	9.525	16	1.1	1.5	⊗	○
1880862	16 ER 9 UN	9	9.525	16	1.2	1.7	⊗	○

Stock item | Produto de stock | Itens de stock

Available under request | Disponível sobre consulta | Disponible bajo consulta

Note: Order Code = (1) + (2)
See page E - 694 for more detail information

External

Geometry code (1) Código	Reference Referência Referencia	Pitch MM	Dimensions Dimensões Dimensiones (mm)				Stock - Grade Code (2)	
			IC	L	X	Y	(68) PH6920	(D0) PH8920
1880024	16 ER 8 UN	8	9.525	16	1.2	1.6	○	○
1880861	22 ER 7 UN	7	12.70	22	1.6	2.3	○	○
1880860	22 ER 6 UN	6	12.70	22	1.6	2.3	⊗	○
1880859	22 ER 5 UN	5	12.70	22	1.7	2.5	○	○
1882157	27 ER 4.5 UN	4.5	15.875	27	1.9	2.7	○	○
1882161	27 ER 4 UN	4	15.875	27	2.1	3.0	○	○
1881848	11 EL 72 UN	72	6.35	11	0.8	0.4	○	○
1881847	11 EL 64 UN	64	6.35	11	0.8	0.4	○	○
1882200	11 EL 56 UN	56	6.35	11	0.7	0.4	○	○
1881843	11 EL 48 UN	48	6.35	11	0.6	0.6	○	○
1881842	11 EL 44 UN	44	6.35	11	0.6	0.6	○	○
1881840	11 EL 40 UN	40	6.35	11	0.6	0.6	○	○
1881838	11 EL 36 UN	36	6.35	11	0.6	0.6	○	○
1881836	11 EL 32 UN	32	6.35	11	0.6	0.6	○	○
1881834	11 EL 28 UN	28	6.35	11	0.6	0.7	○	○
1881832	11 EL 27 UN	27	6.35	11	0.7	0.8	○	○
1881827	11 EL 24 UN	24	6.35	11	0.7	0.8	○	○
1881824	11 EL 20 UN	20	6.35	11	0.8	0.9	○	○
1881819	11 EL 18 UN	18	6.35	11	0.8	1.0	○	○
1881815	11 EL 16 UN	16	6.35	11	0.9	1.1	○	○
1881811	11 EL 14 UN	14	6.35	11	0.9	1.1	○	○
1882022	16 EL 72 UN	72	9.525	16	0.8	0.3	○	○
1882020	16 EL 64 UN	64	9.525	16	0.8	0.4	○	○
1882017	16 EL 56 UN	56	9.525	16	0.7	0.4	○	○
1882015	16 EL 48 UN	48	9.525	16	0.6	0.6	○	○
1882014	16 EL 44 UN	44	9.525	16	0.6	0.6	○	○
1882012	16 EL 40 UN	40	9.525	16	0.6	0.6	○	○
1882010	16 EL 36 UN	36	9.525	16	0.6	0.6	○	○
1880886	16 EL 32 UN	32	9.525	16	0.6	0.6	○	○
1880885	16 EL 28 UN	28	9.525	16	0.6	0.7	○	○
1882007	16 EL 27 UN	27	9.525	16	0.7	0.8	○	○
1880884	16 EL 24 UN	24	9.525	16	0.7	0.8	○	○
1880883	16 EL 20 UN	20	9.525	16	0.8	0.9	○	○
1880882	16 EL 18 UN	18	9.525	16	0.8	1.0	○	○
1880881	16 EL 16 UN	16	9.525	16	0.9	1.1	○	○
1880880	16 EL 14 UN	14	9.525	16	1.0	1.2	○	○
1880879	16 EL 13 UN	13	9.525	16	1.0	1.3	○	○
1880878	16 EL 12 UN	12	9.525	16	1.1	1.4	○	○
1883755	16 EL 11.5 UN	11.5	9.525	16	1.1	1.5	○	○
1880877	16 EL 11 UN	11	9.525	16	1.1	1.5	○	○
1880876	16 EL 10 UN	10	9.525	16	1.1	1.5	○	○
1880875	16 EL 9 UN	9	9.525	16	1.2	1.7	○	○
1880874	16 EL 8 UN	8	9.525	16	1.2	1.6	○	○
1880873	22 EL 7U N	7	12.70	22	1.6	2.3	○	○
1880872	22 EL 6 UN	6	12.70	22	1.6	2.3	○	○
1880871	22 EL 5 UN	5	12.70	22	1.7	2.5	○	○
1882144	27 EL 4.5 UN	4.5	15.875	27	1.9	2.7	○	○
1882148	27 EL 4 UN	4	15.875	27	2.1	3.0	○	○

Stock item | Produto de stock | Itens de stock

Available under request | Disponível sobre consulta | Disponible bajo consulta

Note: Order Code = (1) + (2)
See page E - 694 for more detail information

AMERICAN UN (UNC, UNF, UNEF) | ANSI B1.1-1982

Internal

Geometry code (1) Código	Reference Referência Referencia	Pitch	Dimensions Dimensões Dimensiones (mm)				Stock - Grade Code (2)	
		MM	IC	L	X	Y	(68) PH6920	(D0) PH8920
1881726	06 IR 32 UN	32	4.00	06	0.8	0.5	○	○
1881725	06 IR 28 UN	28	4.00	06	0.8	0.6	○	○
1881722	06 IR 24 UN	24	4.00	06	0.7	0.6	○	○
1883756	06 IR 20 UN	20	4.00	06	0.6	0.6	○	○
1881721	06 IR 18 UN	18	4.00	06	0.6	0.7	○	○
1881769	08 IR 32 UN	32	5.00	08	0.6	0.5	○	○
1881768	08 IR 28 UN	28	5.00	08	0.6	0.6	○	○
1881765	08 IR 24 UN	24	5.00	08	0.6	0.6	○	○
1881764	08 IR 20 UN	20	5.00	08	0.6	0.7	⊗	○
1881762	08 IR 18 UN	18	5.00	08	0.6	0.7	○	○
1881760	08 IR 16 UN	16	5.00	08	0.6	0.7	○	○
1881759	08 IR 14 UN	14	5.00	08	0.6	0.8	○	○
1881956	11 IR 72 UN	72	6.35	11	0.8	0.3	○	○
1881955	11 IR 64 UN	64	6.35	11	0.8	0.4	○	○
1881954	11 IR 56 UN	56	6.35	11	0.7	0.4	○	○
1881953	11 IR 48 UN	48	6.35	11	0.6	0.6	○	○
1881952	11 IR 44 UN	44	6.35	11	0.6	0.6	○	○
1881951	11 IR 40 UN	40	6.35	11	0.6	0.6	○	○
1881950	11 IR 36 UN	36	6.35	11	0.6	0.6	○	○
1880910	11 IR 32 UN	32	6.35	11	0.6	0.6	○	○
1880909	11 IR 28 UN	28	6.35	11	0.6	0.7	○	○
1881948	11 IR 27 UN	27	6.35	11	0.7	0.8	○	○
1880908	11 IR 24 UN	24	6.35	11	0.7	0.8	○	○
1880907	11 IR 20 UN	20	6.35	11	0.8	0.9	○	○
1880906	11 IR 18 UN	18	6.35	11	0.8	1.0	○	○
1880905	11 IR 16 UN	16	6.35	11	0.9	1.1	⊗	○
1880904	11 IR 14 UN	14	6.35	11	0.9	1.1	⊗	○
1880903	11 IR 13 UN	13	6.35	11	0.8	1.0	○	○
1880902	11 IR 12 UN	12	6.35	11	0.9	1.1	⊗	○
1880901	11 IR 11 UN	11	6.35	11	0.8	1.1	○	○
1882126	16 IR 72 UN	72	9.525	16	0.8	0.3	○	○
1882124	16 IR 64 UN	64	9.525	16	0.8	0.4	○	○
1882123	16 IR 56 UN	56	9.525	16	0.7	0.4	○	○
1882122	16 IR 48 UN	48	9.525	16	0.6	0.6	○	○
1882121	16 IR 44 UN	44	9.525	16	0.6	0.6	○	○
1882120	16 IR 40 UN	40	9.525	16	0.6	0.6	○	○
1882118	16 IR 36 UN	36	9.525	16	0.6	0.6	○	○
1880900	16 IR 32 UN	32	9.525	16	0.6	0.6	○	○
1880899	16 IR 28 UN	28	9.525	16	0.6	0.7	○	○
1882117	16 IR 27 UN	27	9.525	16	0.7	0.8	○	○
1880898	16 IR 24 UN	24	9.525	16	0.7	0.8	○	○
1880618	16 IR 20 UN	20	9.525	16	0.8	0.9	⊗	○
1880897	16 IR 18 UN	18	9.525	16	0.8	1.0	⊗	○
1880037	16 IR 16 UN	16	9.525	16	0.9	1.1	○	○
1880034	16 IR 14 UN	14	9.525	16	1.0	1.2	○	○
1882116	16 IR 13 UN	13	9.525	16	1.0	1.3	○	○

⊗ Stock item | Produto de stock | Itens de stock ○ Available under request | Disponível sobre consulta | Disponible bajo consulta

Note: Order Code = (1) + (2)
See page E - 694 for more detail information

Internal

Geometry code (1) Código	Reference Referência Referencia	Pitch	Dimensions Dimensões Dimensiones (mm)				Stock - Grade Code (2)	
		MM	IC	L	X	Y	(68) PH6920	(D0) PH8920
1880894	16 IR 12 UN	12	9.525	16	1.1	1.4	⊗	○
1883757	16 IR 11.5 UN	11.5	9.525	16	1.1	1.5	○	○
1880893	16 IR 11 UN	11	9.525	16	1.1	1.5	○	○
1880892	16 IR 10 UN	10	9.525	16	1.1	1.5	○	○
1880891	16 IR 9 UN	9	9.525	16	1.2	1.7	○	○
1880044	16 IR 8 UN	8	9.525	16	1.2	1.6	○	○
1880889	22 IR 7 UN	7	12.70	22	1.6	2.3	○	○
1880888	22 IR 6 UN	6	12.70	22	1.6	2.3	○	○
1880887	22 IR 5 UN	5	12.70	22	1.6	2.3	○	○
1882181	27 IR 4.5 UN	4.5	15.875	27	1.7	2.4	○	○
1882184	27 IR 4 UN	4	15.875	27	1.8	2.7	○	○
1881712	06 IL 32 UN	32	4.00	06	0.8	0.5	○	○
1881711	06 IL 28 UN	28	4.00	06	0.8	0.6	○	○
1881708	06 IL 24 UN	24	4.00	06	0.7	0.6	○	○
1883758	06 IL 20 UN	20	4.00	06	0.6	0.6	○	○
1881707	06 IL 18 UN	18	4.00	06	0.6	0.7	○	○
1881748	08 IL 32 UN	32	5.00	08	0.6	0.5	○	○
1881747	08 IL 28 UN	28	5.00	08	0.6	0.6	○	○
1881744	08 IL 24 UN	24	5.00	08	0.6	0.6	○	○
1881743	08 IL 20 UN	20	5.00	08	0.6	0.7	○	○
1881741	08 IL 18 UN	18	5.00	08	0.6	0.7	○	○
1881739	08 IL 16 UN	16	5.00	08	0.6	0.7	○	○
1881738	08 IL 14 UN	14	5.00	08	0.6	0.8	○	○
1881936	11 IL 72 UN	72	6.35	11	0.8	0.3	○	○
1881935	11 IL 64 UN	64	6.35	11	0.8	0.4	○	○
1881934	11 IL 56 UN	56	6.35	11	0.7	0.4	○	○
1881933	11 IL 48 UN	48	6.35	11	0.6	0.6	○	○
1881932	11 IL 44 UN	44	6.35	11	0.6	0.6	○	○
1881931	11 IL 40 UN	40	6.35	11	0.6	0.6	○	○
1881930	11 IL 36 UN	36	6.35	11	0.6	0.6	○	○
1880935	11 IL 32 UN	32	6.35	11	0.6	0.6	○	○
1880934	11 IL 28 UN	28	6.35	11	0.6	0.7	○	○
1881928	11 IL 27 UN	27	6.35	11	0.7	0.8	○	○
1880933	11 IL 24 UN	24	6.35	11	0.7	0.8	○	○
1880932	11 IL 20 UN	20	6.35	11	0.8	0.9	○	○
1880931	11 IL 18 UN	18	6.35	11	0.8	1.0	○	○
1880930	11 IL 16 UN	16	6.35	11	0.9	1.1	○	○
1880929	11 IL 14 UN	14	6.35	11	0.9	1.1	○	○
1880928	11 IL 13 UN	13	6.35	11	0.8	1.0	○	○
1880927	11 IL 12 UN	12	6.35	11	0.9	1.1	○	○
1880926	11 IL 11 UN	11	6.35	11	0.8	1.1	○	○
1882101	16 IL 72 UN	72	9.525	16	0.8	0.3	○	○
1882098	16 IL 64 UN	64	9.525	16	0.8	0.4	○	○
1882097	16 IL 56 UN	56	9.525	16	0.7	0.4	○	○
1882096	16 IL 48 UN	48	9.525	16	0.6	0.6	○	○
1882095	16 IL 44 UN	44	9.525	16	0.6	0.6	○	○

⊗ Stock item | Produto de stock | Itens de stock ○ Available under request | Disponível sobre consulta | Disponible bajo consulta

Note: Order Code = (1) + (2)
See page E - 694 for more detail information

THREADING

THREADING

Internal

Geometry code (1) Código	Reference Referência Referencia	Pitch	Dimensions Dimensões Dimensiones (mm)				Stock - Grade Code (2)	
		MM	IC	L	X	Y	(68) PH6920	(D0) PH8920
1882094	16 IL 40 UN	40	9.525	16	0.6	0.6	○	○
1882092	16 IL 36 UN	36	9.525	16	0.6	0.6	○	○
1880925	16 IL 32 UN	32	9.525	16	0.6	0.6	○	○
1880924	16 IL 28 UN	28	9.525	16	0.6	0.7	○	○
1882089	16 IL 27 UN	27	9.525	16	0.7	0.8	○	○
1880923	16 IL 24 UN	24	9.525	16	0.7	0.8	○	○
1880922	16 IL 20 UN	20	9.525	16	0.8	0.9	○	○
1880921	16 IL 18 UN	18	9.525	16	0.8	1.0	○	○
1880920	16 IL 16 UN	16	9.525	16	0.9	1.1	○	○
1880919	16 IL 14 UN	14	9.525	16	1.0	1.2	○	○
1882074	16 IL 13 UN	13	9.525	16	1.0	1.3	○	○
1880918	16 IL 12 UN	12	9.525	16	1.1	1.4	○	○
1883759	16 IL 11.5 UN	11.5	9.525	16	1.1	1.5	○	○
1880917	16 IL 11 UN	11	9.525	16	1.1	1.5	○	○
1880916	16 IL 10 UN	10	9.525	16	1.1	1.5	○	○
1880915	16 IL 9 UN	9	9.525	16	1.2	1.7	○	○
1880914	16 IL 8 UN	8	9.525	16	1.2	1.6	○	○
1880913	22 IL 7 UN	7	12.70	22	1.6	2.3	○	○
1880912	22 IL 6 UN	6	12.70	22	1.6	2.3	○	○
1880911	22 IL 5 UN	5	12.70	22	1.6	2.3	○	○
1882170	27 IL 4.5 UN	4.5	15.875	27	1.7	2.4	○	○
1882173	27 IL 4 UN	4	15.875	27	1.8	2.7	○	○

Stock item | Produto de stock | Itens de stock

Available under request | Disponível sobre consulta | Disponible bajo consulta

Note: Order Code = (1) + (2)
See page E - 694 for more detail information

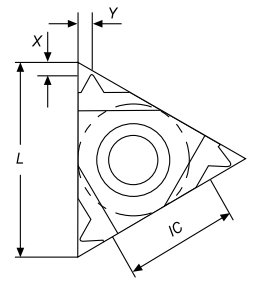
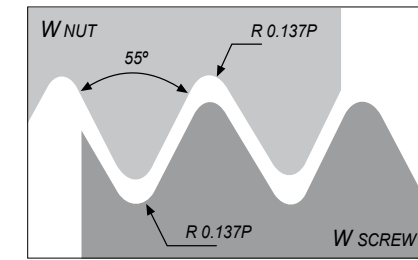
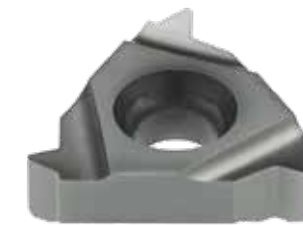

External

Geometry code (1) Código	Reference Referência Referencia	Pitch	Dimensions Dimensões Dimensiones (mm)				Stock - Grade Code (2)	
		TPI	IC	L	X	Y	(68) PH6920	(D0) PH8920
1881908	11 ER 72 W	72	6.35	11	0.7	0.4	○	○
1881905	11 ER 60 W	60	6.35	11	0.7	0.4	○	○
1881904	11 ER 56 W	56	6.35	11	0.7	0.4	○	○
1881902	11 ER 48 W	48	6.35	11	0.6	0.6	○	○
1881899	11 ER 40 W	40	6.35	11	0.6	0.6	○	○
1881897	11 ER 36 W	36	6.35	11	0.6	0.6	○	○
1881895	11 ER 32 W	32	6.35	11	0.6	0.6	○	○
1881893	11 ER 28 W	28	6.35	11	0.6	0.7	○	○
1881887	11 ER 26 W	26	6.35	11	0.7	0.7	○	○
1881886	11 ER 24 W	24	6.35	11	0.7	0.8	○	○
1881884	11 ER 22 W	22	6.35	11	0.8	0.9	○	○
1881883	11 ER 20 W	20	6.35	11	0.8	0.9	○	○
1881880	11 ER 19 W	19	6.35	11	0.8	1.0	○	○
1881878	11 ER 18 W	18	6.35	11	0.8	1.0	○	○
1881874	11 ER 16 W	16	6.35	11	0.9	1.1	○	○
1881870	11 ER 14 W	14	6.35	11	0.9	1.1	○	○
1882056	16 ER 72 W	72	9.525	16	0.7	0.4	○	○
1882053	16 ER 60 W	60	9.525	16	0.7	0.4	○	○
1882052	16 ER 56 W	56	9.525	16	0.7	0.4	○	○
1882050	16 ER 48 W	48	9.525	16	0.6	0.6	○	○
1882047	16 ER 40 W	40	9.525	16	0.6	0.6	○	○
1882045	16 ER 36 W	36	9.525	16	0.6	0.6	○	○
1882043	16 ER 32 W	32	9.525	16	0.6	0.6	○	○
1880940	16 ER 28 W	28	9.525	16	0.6	0.7	○	○
1882040	16 ER 26 W	26	9.525	16	0.7	0.7	○	○
1880939	16 ER 24 W	24	9.525	16	0.7	0.8	○	○
1882039	16 ER 22 W	22	9.525	16	0.8	0.9	○	○
1880938	16 ER 20 W	20	9.525	16	0.8	0.9	⊗	○
1880017	16 ER 19 W	19	9.525	16	0.8	1.0	⊗	○
1880937	16 ER 18 W	18	9.525	16	0.8	1.0	○	○
1880609	16 ER 16 W	16	9.525	16	0.9	1.1	⊗	○
1880015	16 ER 14 W	14	9.525	16	1.0	1.2	⊗	○
1880611	16 ER 12 W	12	9.525	16	1.1	1.4	⊗	○
1880613	16 ER 11 W	11	9.525	16	1.1	1.5	⊗	○
1880614	16 ER 10 W	10	9.525	16	1.1	1.5	○	○
1880936	16 ER 9 W	9	9.525	16	1.2	1.7	○	○

Stock item | Produto de stock | Itens de stock

Available under request | Disponível sobre consulta | Disponible bajo consulta

Note: Order Code = (1) + (2)
See page E - 694 for more detail information

External

Geometry code (1) Código	Reference Referência Referencia	Pitch TPI	Dimensions Dimensões Dimensiones (mm)				Stock - Grade Code (2)	
			IC	L	X	Y	(68) PH6920	(D0) PH8920
1880646	16 ER 8 W	8	9.525	16	1.2	1.5	☉	○
1880941	22 ER 7 W	7	12.70	22	1.6	2.3	☉	○
1880942	22 ER 6 W	6	12.70	22	1.6	2.3	○	○
1880943	22 ER 5 W	5	12.70	22	1.7	2.4	○	○
1882158	27 ER 4.5 W	4.5	15.875	27	1.8	2.6	○	○
1882162	27 ER 4 W	4	15.875	27	2.0	2.9	○	○
1881849	11 EL 72 W	72	6.35	11	0.7	0.4	○	○
1881846	11 EL 60 W	60	6.35	11	0.7	0.4	○	○
1881845	11 EL 56 W	56	6.35	11	0.7	0.4	○	○
1881844	11 EL 48 W	48	6.35	11	0.6	0.6	○	○
1881841	11 EL 40 W	40	6.35	11	0.6	0.6	○	○
1881839	11 EL 36 W	36	6.35	11	0.6	0.6	○	○
1881837	11 EL 32 W	32	6.35	11	0.6	0.6	○	○
1881835	11 EL 28 W	28	6.35	11	0.6	0.7	○	○
1881829	11 EL 26 W	26	6.35	11	0.7	0.7	○	○
1881828	11 EL 24 W	24	6.35	11	0.7	0.8	○	○
1881826	11 EL 22 W	22	6.35	11	0.8	0.9	○	○
1881825	11 EL 20 W	20	6.35	11	0.8	0.9	○	○
1881822	11 EL 19 W	19	6.35	11	0.8	1.0	○	○
1881820	11 EL 18 W	18	6.35	11	0.8	1.0	○	○
1881816	11 EL 16 W	16	6.35	11	0.9	1.1	○	○
1881812	11 EL 14 W	14	6.35	11	0.9	1.1	○	○
1882023	16 EL 72 W	72	9.525	16	0.7	0.4	○	○
1882019	16 EL 60 W	60	9.525	16	0.7	0.4	○	○
1882018	16 EL 56 W	56	9.525	16	0.7	0.4	○	○
1882016	16 EL 48 W	48	9.525	16	0.6	0.6	○	○
1882013	16 EL 40 W	40	9.525	16	0.6	0.6	○	○
1882011	16 EL 36 W	36	9.525	16	0.6	0.6	○	○
1882009	16 EL 32 W	32	9.525	16	0.6	0.6	○	○
1880955	16 EL 28 W	28	9.525	16	0.6	0.7	○	○
1882004	16 EL 26 W	26	9.525	16	0.6	0.7	○	○
1880954	16 EL 24 W	24	9.525	16	0.7	0.8	○	○
1882003	16 EL 22 W	22	9.525	16	0.8	0.9	○	○
1880953	16 EL 20 W	20	9.525	16	0.8	0.9	○	○
1880952	16 EL 19 W	19	9.525	16	0.8	1.0	○	○
1880951	16 EL 18 W	18	9.525	16	0.8	1.0	○	○
1880950	16 EL 16 W	16	9.525	16	0.9	1.1	○	○
1880949	16 EL 14 W	14	9.525	16	1.0	1.2	☉	○
1880948	16 EL 12 W	12	9.525	16	1.1	1.4	○	○
1880947	16 EL 11 W	11	9.525	16	1.1	1.5	○	○
1880946	16 EL 10 W	10	9.525	16	1.1	1.5	○	○
1880945	16 EL 9 W	9	9.525	16	1.2	1.7	○	○
1880944	16 EL 8 W	8	9.525	16	1.2	1.5	○	○
1880956	22 EL 7 W	7	12.70	22	1.6	2.3	○	○
1880957	22 EL 6 W	6	12.70	22	1.6	2.3	○	○
1880958	22 EL 5 W	5	12.70	22	1.7	2.4	○	○
1882145	27 EL 4.5 W	4.5	15.875	27	1.8	2.6	○	○
1882149	27 EL 4 W	4	15.875	27	2.0	2.9	○	○

☉ Stock item | Produto de stock | Itens de stock ○ Available under request | Disponível sobre consulta | Disponible bajo consulta

Note: Order Code = (1) + (2)
See page E - 694 for more detail information

Internal

Geometry code (1) Código	Reference Referência Referencia	Pitch TPI	Dimensions Dimensões Dimensiones (mm)				Stock - Grade Code (2)	
			IC	L	X	Y	(68) PH6920	(D0) PH8920
1882203	06 IR 26 W	26	4.00	06	0.7	0.6	○	○
1882207	06 IR 22 W	22	4.00	06	0.6	0.6	○	○
1883760	06 IR 20 W	20	4.00	06	0.6	0.7	○	○
1882211	06 IR 18 W	18	4.00	06	0.6	0.7	○	○
1882213	08 IR 28 W	28	5.00	08	0.6	0.6	○	○
1882217	08 IR 24 W	24	5.00	08	0.6	0.6	○	○
1882219	08 IR 20 W	20	5.00	08	0.6	0.7	○	○
1882221	08 IR 19 W	19	5.00	08	0.6	0.7	○	○
1882223	08 IR 18 W	18	5.00	08	0.6	0.7	○	○
1882225	08 IR 16 W	16	5.00	08	0.6	0.7	○	○
1882227	11 IR 72 W	72	6.35	11	0.7	0.4	○	○
1882229	11 IR 60 W	60	6.35	11	0.7	0.4	○	○
1882231	11 IR 56 W	56	6.35	11	0.7	0.4	○	○
1882233	11 IR 48 W	48	6.35	11	0.6	0.6	○	○
1882235	11 IR 40 W	40	6.35	11	0.6	0.6	○	○
1883761	11 IR 36 W	36	6.35	11	0.6	0.6	○	○
1882237	11 IR 32 W	32	6.35	11	0.6	0.6	○	○
1880972	11 IR 28 W	28	6.35	11	0.6	0.7	○	○
1882239	11 IR 26 W	26	6.35	11	0.7	0.7	○	○
1880971	11 IR 24 W	24	6.35	11	0.7	0.8	○	○
1883762	11 IR 22 W	22	6.35	11	0.8	0.9	○	○
1880970	11 IR 20 W	20	6.35	11	0.8	0.9	○	○
1880005	11 IR 19 W	19	6.35	11	0.8	1.0	○	○
1880968	11 IR 18 W	18	6.35	11	0.8	1.0	☉	○
1880967	11 IR 16 W	16	6.35	11	0.9	1.1	○	○
1880004	11 IR 14 W	14	6.35	11	0.9	1.1	☉	○
1883763	11 IR 12 W	12	6.35	11	1.0	1.1	○	○
1883764	11 IR 11 W	11	6.35	11	0.9	1.2	○	○
1882241	16 IR 72 W	72	9.525	16	0.7	0.4	○	○
1882498	16 IR 60 W	60	9.525	16	0.7	0.4	○	○
1882244	16 IR 56 W	56	9.525	16	0.7	0.4	○	○
1882246	16 IR 48 W	48	9.525	16	0.6	0.6	○	○
1882248	16 IR 40 W	40	9.525	16	0.6	0.6	○	○
1882250	16 IR 36 W	36	9.525	16	0.6	0.6	○	○
1882252	16 IR 32 W	32	9.525	16	0.6	0.6	○	○
1880965	16 IR 28 W	28	9.525	16	0.6	0.7	○	○
1882254	16 IR 26 W	26	9.525	16	0.6	0.7	○	○
1880964	16 IR 24 W	24	9.525	16	0.7	0.8	○	○
1882256	16 IR 22 W	22	9.525	16	0.8	0.9	○	○
1880963	16 IR 20 W	20	9.525	16	0.8	0.9	☉	○
1880608	16 IR 19 W	19	9.525	16	0.8	1.0	☉	○
1880962	16 IR 18 W	18	9.525	16	0.8	1.0	○	○
1880610	16 IR 16 W	16	9.525	16	0.9	1.1	○	○
1880035	16 IR 14 W	14	9.525	16	1.0	1.2	☉	○
1880612	16 IR 12 W	12	9.525	16	1.1	1.4	○	○
1880031	16 IR 11 W	11	9.525	16	1.1	1.5	☉	○

☉ Stock item | Produto de stock | Itens de stock ○ Available under request | Disponível sobre consulta | Disponible bajo consulta

Note: Order Code = (1) + (2)
See page E - 694 for more detail information

THREADING

THREADING

Internal

Geometry code (1) Código	Reference Referência Referencia	Pitch TPI	Dimensions Dimensões Dimensiones (mm)				Stock - Grade Code (2)	
			IC	L	X	Y	(68) PH6920	(D0) PH8920
1880615	16 IR 10 W	10	9.525	16	1.1	1.5	○	○
1882258	16 IR 9 W	9	9.525	16	1.2	1.7	○	○
1880672	16 IR 8 W	8	9.525	16	1.2	1.5	⊗	○
1880959	22 IR 7 W	7	12.70	22	1.6	2.3	○	○
1880960	22 IR 6 W	6	12.70	22	1.6	2.3	○	○
1880961	22 IR 5 W	5	12.70	22	1.7	2.4	○	○
1882259	27 IR 4.5 W	4.5	15.875	27	1.8	2.6	○	○
1882261	27 IR 4 W	4	15.875	27	2.0	2.9	○	○
1882204	06 IL 26 W	26	4.00	06	0.7	0.6	○	○
1882208	06 IL 22 W	22	4.00	06	0.6	0.6	○	○
1883765	06 IL 20 W	20	4.00	06	0.6	0.7	○	○
1882212	06 IL 18 W	18	4.00	06	0.6	0.7	○	○
1882214	08 IL 28 W	28	5.00	08	0.7	0.7	○	○
1882218	08 IL 24 W	24	5.00	08	0.7	0.7	○	○
1882220	08 IL 20 W	20	5.00	08	0.7	0.7	○	○
1882222	08 IL 19 W	19	5.00	08	0.7	0.7	○	○
1882224	08 IL 18 W	18	5.00	08	0.7	0.7	○	○
1882226	08 IL 16 W	16	5.00	08	0.7	0.7	○	○
1882228	11 IL 72 W	72	6.35	11	0.7	0.4	○	○
1882230	11 IL 60 W	60	6.35	11	0.7	0.4	○	○
1882232	11 IL 56 W	56	6.35	11	0.7	0.4	○	○
1882234	11 IL 48 W	48	6.35	11	0.6	0.6	○	○
1882236	11 IL 40 W	40	6.35	11	0.6	0.6	○	○
1883766	11 IL 36 W	36	6.35	11	0.6	0.6	○	○
1882238	11 IL 32 W	32	6.35	11	0.6	0.6	○	○
1880994	11 IL 28 W	28	6.35	11	0.6	0.7	○	○
1882240	11 IL 26 W	26	6.35	11	0.7	0.7	○	○
1880993	11 IL 24 W	24	6.35	11	0.7	0.8	○	○
1883767	11 IL 22 W	22	6.35	11	0.8	0.9	○	○
1880992	11 IL 20 W	20	6.35	11	0.8	0.9	○	○
1880991	11 IL 19 W	19	6.35	11	0.8	1.0	○	○
1880990	11 IL 18 W	18	6.35	11	0.8	1.0	○	○
1880989	11 IL 16 W	16	6.35	11	0.9	1.1	○	○
1880988	11 IL 14 W	14	6.35	11	0.9	1.1	○	○
1883768	11 IL 12 W	12	6.35	11	1.0	1.1	○	○
1883769	11 IL 11 W	11	6.35	11	0.9	1.2	○	○
1882242	16 IL 72 W	72	9.525	16	0.7	0.4	○	○
1882243	16 IL 60 W	60	9.525	16	0.7	0.4	○	○
1882245	16 IL 56 W	56	9.525	16	0.7	0.4	○	○
1882247	16 IL 48 W	48	9.525	16	0.6	0.6	○	○

⊗ Stock item | Produto de stock | Itens de stock ○ Available under request | Disponível sobre consulta | Disponible bajo consulta

Note: Order Code = (1) + (2)
See page E - 694 for more detail information

Internal

Geometry code (1) Código	Reference Referência Referencia	Pitch TPI	Dimensions Dimensões Dimensiones (mm)				Stock - Grade Code (2)	
			IC	L	X	Y	(68) PH6920	(D0) PH8920
1882249	16 IL 40 W	40	9.525	16	0.6	0.6	○	○
1882251	16 IL 36 W	36	9.525	16	0.6	0.6	○	○
1882253	16 IL 32 W	32	9.525	16	0.6	0.6	○	○
1880987	16 IL 28 W	28	9.525	16	0.6	0.7	○	○
1882255	16 IL 26 W	26	9.525	16	0.6	0.7	○	○
1880986	16 IL 24 W	24	9.525	16	0.7	0.8	○	○
1882257	16 IL 22 W	22	9.525	16	0.8	0.9	○	○
1880985	16 IL 20 W	20	9.525	16	0.8	0.9	○	○
1880984	16 IL 19 W	19	9.525	16	0.8	1.0	○	○
1880983	16 IL 18 W	18	9.525	16	0.8	1.0	○	○
1880982	16 IL 16 W	16	9.525	16	0.9	1.1	○	○
1880981	16 IL 14 W	14	9.525	16	1.0	1.2	○	○
1880980	16 IL 12 W	12	9.525	16	1.1	1.4	○	○
1880979	16 IL 11 W	11	9.525	16	1.1	1.5	⊗	○
1880978	16 IL 10 W	10	9.525	16	1.1	1.5	○	○
1880977	16 IL 9 W	9	9.525	16	1.2	1.7	○	○
1880976	16 IL 8 W	8	9.525	16	1.2	1.5	○	○
1880975	22 IL 7 W	7	12.70	22	1.6	2.3	○	○
1880974	22 IL 6 W	6	12.70	22	1.6	2.3	○	○
1880973	22 IL 5 W	5	12.70	22	1.7	2.4	○	○
1882260	27 IL 4.5 W	4.5	15.875	27	1.8	2.6	○	○
1882262	27 IL 4 W	4	15.875	27	2.0	2.9	○	○

⊗ Stock item | Produto de stock | Itens de stock ○ Available under request | Disponível sobre consulta | Disponible bajo consulta

Note: Order Code = (1) + (2)
See page E - 694 for more detail information

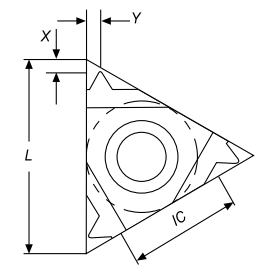
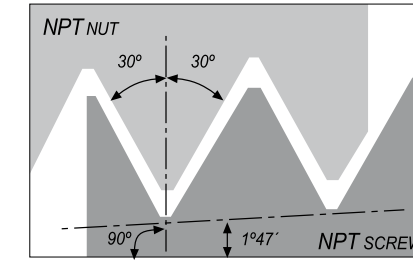
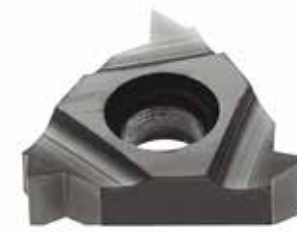
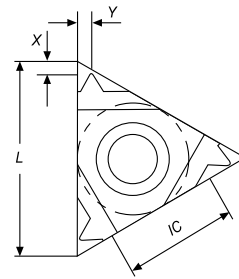
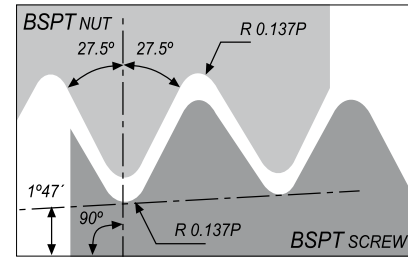
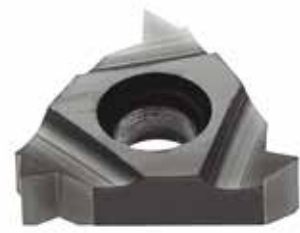

External

Geometry code (1) Código	Reference Referência Referencia	Pitch TPI	Dimensions Dimensões Dimensiones (mm)				Stock - Grade Code (2)	
			IC	L	X	Y	(68) PH6920	(D0) PH8920
1880998	16 ER 28 BSPT	28	9.525	16	0.6	0.6	○	○
1880997	16 ER 19 BSPT	19	9.525	16	0.8	0.9	○	○
1880996	16 ER 14 BSPT	14	9.525	16	1.0	1.2	○	○
1880995	16 ER 11 BSPT	11	9.525	16	1.1	1.5	⊗	○
1882008	16 EL 28 BSPT	28	9.525	16	0.6	0.6	○	○
1882001	16 EL 19 BSPT	19	9.525	16	0.8	0.9	○	○
1881993	16 EL 14 BSPT	14	9.525	16	1.0	1.2	○	○
1881989	16 EL 11 BSPT	11	9.525	16	1.1	1.5	○	○

⊗ Stock item | Produto de stock | Itens de stock

○ Available under request | Disponível sobre consulta | Disponible bajo consulta

Note: Order Code = (1) + (2)
See page E - 694 for more detail information

External

Geometry code (1) Código	Reference Referência Referencia	Pitch TPI	Dimensions Dimensões Dimensiones (mm)				Stock - Grade Code (2)	
			IC	L	X	Y	(68) PH6920	(D0) PH8920
1881888	11 ER 27 NPT	27	6.35	11	0.7	0.8	○	○
1881875	11 ER 18 NPT	18	6.35	11	0.8	1.0	○	○
1881867	11 ER 14 NPT	14	6.35	11	0.8	1.0	○	○
1881017	16 ER 27 NPT	27	9.525	16	0.7	0.8	⊗	○
1881016	16 ER 18 NPT	18	9.525	16	0.8	1.0	⊗	○
1880013	16 ER 14 NPT	14	9.525	16	0.9	1.2	⊗	○
1880009	16 ER 11.5 NPT	11.5	9.525	16	1.1	1.5	⊗	○
1880023	16 ER 8 NPT	8	9.525	16	1.3	1.8	○	○
1881830	11 EL 27 NPT	27	6.35	11	0.7	0.8	○	○
1881817	11 EL 18 NPT	18	6.35	11	0.8	1.0	○	○
1881809	11 EL 14 NPT	14	6.35	11	0.8	1.0	○	○
1882005	16 EL 27 NPT	27	9.525	16	0.7	0.8	○	○
1881999	16 EL 18 NPT	18	9.525	16	0.8	1.0	○	○
1881994	16 EL 14 NPT	14	9.525	16	0.9	1.2	○	○
1881987	16 EL 11.5 NPT	11.5	9.525	16	1.1	1.5	○	○
1882025	16 EL 8 NPT	8	9.525	16	1.3	1.8	○	○

⊗ Stock item | Produto de stock | Itens de stock

○ Available under request | Disponível sobre consulta | Disponible bajo consulta

Note: Order Code = (1) + (2)
See page E - 694 for more detail information

Internal

Geometry code (1) Código	Reference Referência Referencia	Pitch TPI	Dimensions Dimensões Dimensiones (mm)				Stock - Grade Code (2)	
			IC	L	X	Y	(68) PH6920	(D0) PH8920
1881724	06 IR 28 BSPT	28	4.00	06	0.7	0.6	○	○
1881767	08 IR 28 BSPT	28	5.00	08	0.6	0.6	○	○
1881763	08 IR 19 BSPT	19	5.00	08	0.6	0.6	○	○
1881949	11 IR 28 BSPT	28	6.35	11	0.6	0.6	○	○
1881004	11 IR 19 BSPT	19	6.35	11	0.8	0.9	○	○
1881003	11 IR 14 BSPT	14	6.35	11	0.9	1.0	○	○
1883770	11 IR 11 BSPT	11	6.35	11	0.9	1.2	○	○
1881002	16 IR 28 BSPT	28	9.525	16	0.6	0.6	○	○
1881001	16 IR 19 BSPT	19	9.525	16	0.8	0.9	○	○
1881000	16 IR 14 BSPT	14	9.525	16	1.0	1.2	○	○
1880999	16 IR 11 BSPT	11	9.525	16	1.1	1.5	○	○
1881710	06 IL 28 BSPT	28	4.00	06	0.7	0.6	○	○
1881746	08 IL 28 BSPT	28	5.00	08	0.6	0.6	○	○
1881742	08 IL 19 BSPT	19	5.00	08	0.6	0.6	○	○
1881929	11 IL 28 BSPT	28	6.35	11	0.6	0.6	○	○
1881925	11 IL 19 BSPT	19	6.35	11	0.8	0.9	○	○
1881918	11 IL 14 BSPT	14	6.35	11	0.9	1.0	○	○
1883771	11 IL 11 BSPT	11	6.35	11	0.9	1.2	○	○
1882090	16 IL 28 BSPT	28	9.525	16	0.6	0.6	○	○
1882084	16 IL 19 BSPT	19	9.525	16	0.8	0.9	○	○
1882076	16 IL 14 BSPT	14	9.525	16	1.0	1.2	○	○
1882071	16 IL 11 BSPT	11	9.525	16	1.1	1.5	○	○

⊗ Stock item | Produto de stock | Itens de stock

○ Available under request | Disponível sobre consulta | Disponible bajo consulta

Note: Order Code = (1) + (2)
See page E - 694 for more detail information

THREADING

THREADING

NPT | ANSI/ASME B 1.20.1-1983

Internal

Geometry code (1) Código	Reference Referência Referencia	Pitch	Dimensions Dimensões Dimensiones (mm)				Stock - Grade Code (2)	
		TPI	IC	L	X	Y	(68) PH6920	(D0) PH8920
1881723	06 IR 27 NPT	27	4.00	06	0.6	0.6	○	○
1881766	08 IR 27 NPT	27	5.00	08	0.6	0.6	○	○
1881761	08 IR 18 NPT	18	5.00	08	0.6	0.6	○	○
1881946	11 IR 27 NPT	27	6.35	11	0.7	0.8	○	○
1881020	11 IR 18 NPT	18	6.35	11	0.8	1.0	⊗	○
1880003	11 IR 14 NPT	14	6.35	11	0.8	1.0	⊗	○
1881019	16 IR 27 NPT	27	9.525	16	0.7	0.8	○	○
1881018	16 IR 18 NPT	18	9.525	16	0.8	1.0	⊗	○
1880033	16 IR 14 NPT	14	9.525	16	0.9	1.2	⊗	○
1880029	16 IR 11.5 NPT	11.5	9.525	16	1.1	1.5	○	○
1880043	16 IR 8 NPT	8	9.525	16	1.3	1.8	○	○
1881709	06 IL 27 NPT	27	4.00	06	0.6	0.6	○	○
1881745	08 IL 27 NPT	27	5.00	08	0.6	0.6	○	○
1881740	08 IL 18 NPT	18	5.00	08	0.6	0.6	○	○
1881926	11 IL 27 NPT	27	6.35	11	0.7	0.8	○	○
1881923	11 IL 18 NPT	18	6.35	11	0.8	1.0	○	○
1881919	11 IL 14 NPT	14	6.35	11	0.8	1.0	○	○
1882087	16 IL 27 NPT	27	9.525	16	0.7	0.8	○	○
1882082	16 IL 18 NPT	18	9.525	16	0.8	1.0	○	○
1882077	16 IL 14 NPT	14	9.525	16	0.9	1.2	○	○
1882069	16 IL 11.5 NPT	11.5	9.525	16	1.1	1.5	○	○
1882103	16 IL 8 NPT	8	9.525	16	1.3	1.8	○	○

⊗ Stock item | Produto de stock | Itens de stock

○ Available under request | Disponível sobre consulta | Disponible bajo consulta

Note: Order Code = (1) + (2)
See page E - 694 for more detail information

NPTF | ANSI B 1.20.3-1976

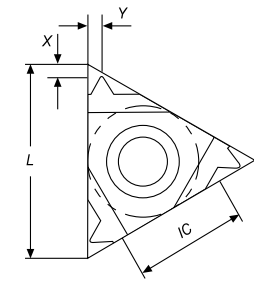
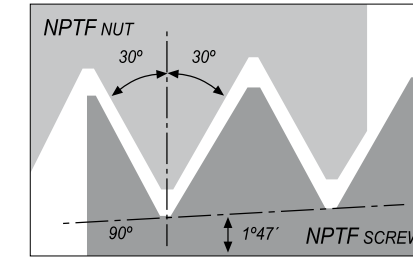
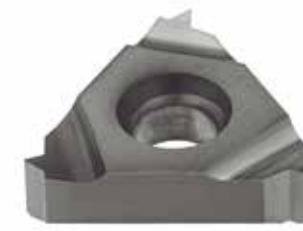

External

Geometry code (1) Código	Reference Referência Referencia	Pitch	Dimensions Dimensões Dimensiones (mm)				Stock - Grade Code (2)	
		TPI	IC	L	X	Y	(68) PH6920	(D0) PH8920
1881889	11 ER 27 NPTF	27	6.35	11	0.7	0.7	○	○
1881876	11 ER 18 NPTF	18	6.35	11	0.8	1.0	○	○
1881868	11 ER 14 NPTF	14	6.35	11	0.8	1.0	○	○
1881030	16 ER 27 NPTF	27	9.525	16	0.7	0.7	⊗	○
1881029	16 ER 18 NPTF	18	9.525	16	0.8	1.0	⊗	○
1881028	16 ER 14 NPTF	14	9.525	16	0.9	1.2	○	○
1881027	16 ER 11.5 NPTF	11.5	9.525	16	1.1	1.5	○	○
1882057	16 ER 8 NPTF	8	9.525	16	1.3	1.8	○	○
1881831	11 EL 27 NPTF	27	6.35	11	0.7	0.7	○	○
1881818	11 EL 18 NPTF	18	6.35	11	0.8	1.0	○	○
1881810	11 EL 14 NPTF	14	6.35	11	0.8	1.0	○	○
1882006	16 EL 27 NPTF	27	9.525	16	0.7	0.8	○	○
1882000	16 EL 18 NPTF	18	9.525	16	0.8	1.0	○	○
1881995	16 EL 14 NPTF	14	9.525	16	0.9	1.2	○	○
1881988	16 EL 11.5 NPTF	11.5	9.525	16	1.1	1.5	○	○
1882026	16 EL 8 NPTF	8	9.525	16	1.3	1.8	○	○

⊗ Stock item | Produto de stock | Itens de stock

○ Available under request | Disponível sobre consulta | Disponible bajo consulta

Note: Order Code = (1) + (2)
See page E - 694 for more detail information

Internal

Geometry code (1) Código	Reference Referência Referencia	Pitch	Dimensions Dimensões Dimensiones (mm)				Stock - Grade Code (2)	
		TPI	IC	L	X	Y	(68) PH6920	(D0) PH8920
1883772	06 IR 27 NPTF	27	4.00	06	0.7	0.6	○	○
1883773	08 IR 18 NPTF	18	5.00	08	0.6	0.6	○	○
1883774	08 IR 14 NPTF	14	5.00	08	0.6	0.6	○	○
1881947	11 IR 27 NPTF	27	6.35	11	0.7	0.7	○	○
1881026	11 IR 18 NPTF	18	6.35	11	0.8	1.0	○	○
1881025	11 IR 14 NPTF	14	6.35	11	0.8	1.0	○	○
1881024	16 IR 27 NPTF	27	9.525	16	0.7	0.7	○	○
1881023	16 IR 18 NPTF	18	9.525	16	0.8	1.0	○	○
1881022	16 IR 14 NPTF	14	9.525	16	0.9	1.2	○	○
1881021	16 IR 11.5 NPTF	11.5	9.525	16	1.1	1.5	○	○
1882127	16 IR 8 NPTF	8	9.525	16	1.3	1.8	○	○
1883775	06 IL 27 NPTF	27	4.00	06	0.7	0.6	○	○
1883776	08 IL 18 NPTF	18	5.00	08	0.6	0.6	○	○
1883777	08 IL 14 NPTF	14	5.00	08	0.6	0.6	○	○
1881927	11 IL 27 NPTF	27	6.35	11	0.7	0.7	○	○
1881924	11 IL 18 NPTF	18	6.35	11	0.8	1.0	○	○
1881920	11 IL 14 NPTF	14	6.35	11	0.8	1.0	○	○
1882088	16 IL 27 NPTF	27	9.525	16	0.7	0.7	○	○
1882083	16 IL 18 NPTF	18	9.525	16	0.8	1.0	○	○
1882078	16 IL 14 NPTF	14	9.525	16	0.9	1.2	○	○
1882070	16 IL 11.5 NPTF	11.5	9.525	16	1.1	1.5	○	○
1882104	16 IL 8 NPTF	8	9.525	16	1.3	1.8	○	○

⊗ Stock item | Produto de stock | Itens de stock ○ Available under request | Disponível sobre consulta | Disponible bajo consulta

Note: Order Code = (1) + (2)
See page E - 694 for more detail information

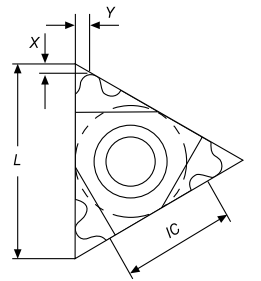
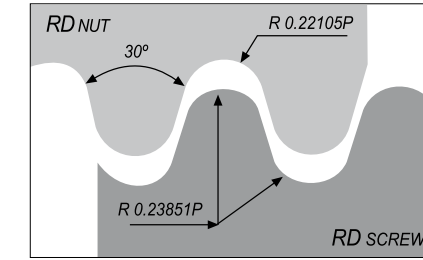
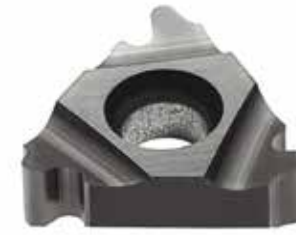

External

Geometry code (1) Código	Reference Referência Referencia	Pitch	Dimensions Dimensões Dimensiones (mm)				Stock - Grade Code (2)	
		TPI	IC	L	X	Y	(68) PH6920	(D0) PH8920
1881031	16 ER 10 RD	10	9.525	16	1.1	1.2	○	○
1881032	16 ER 8 RD	8	9.525	16	1.4	1.4	○	○
1881033	16 ER 6 RD	6	9.525	16	1.4	1.5	○	○
1881034	22 ER 6 RD	6	12.70	22	1.5	1.7	○	○
1881035	22 ER 4 RD	4	12.70	22	2.2	2.3	○	○
1882332	27 ER 4 RD	4	15.875	27	2.2	2.3	○	○
1882333	16 EL 10 RD	10	9.525	16	1.1	1.2	○	○
1882334	16 EL 8 RD	8	9.525	16	1.4	1.4	○	○
1882335	16 EL 6 RD	6	9.525	16	1.4	1.5	○	○
1882336	22 EL 6 RD	6	12.70	22	1.5	1.7	○	○
1882337	22 EL 4 RD	4	12.70	22	2.2	2.3	○	○
1882338	27 EL 4 RD	4	15.875	27	2.2	2.3	○	○

⊗ Stock item | Produto de stock | Itens de stock ○ Available under request | Disponível sobre consulta | Disponible bajo consulta

Note: Order Code = (1) + (2)
See page E - 694 for more detail information

Internal

Geometry code (1) Código	Reference Referência Referencia	Pitch	Dimensions Dimensões Dimensiones (mm)				Stock - Grade Code (2)	
		TPI	IC	L	X	Y	(68) PH6920	(D0) PH8920
1881039	16 IR 10 RD	10	9.525	16	1.1	1.2	⊗	○
1881040	16 IR 8 RD	8	9.525	16	1.4	1.4	⊗	○
1881041	16 IR 6 RD	6	9.525	16	1.4	1.5	○	○
1881042	22 IR 6 RD	6	12.70	22	1.5	1.7	○	○
1881043	22 IR 4 RD	4	12.70	22	2.2	2.3	○	○
1882339	27 IR 4 RD	4	15.875	27	2.2	2.3	○	○
1882340	16 IL 10 RD	10	9.525	16	1.1	1.2	○	○
1882341	16 IL 8 RD	8	9.525	16	1.4	1.4	○	○
1882342	16 IL 6 RD	6	9.525	16	1.4	1.5	○	○
1882343	22 IL 6 RD	6	12.70	22	1.5	1.7	○	○
1882344	22 IL 4 RD	4	12.70	22	2.2	2.3	○	○
1882345	27 IL 4 RD	4	15.875	27	2.2	2.3	○	○

⊗ Stock item | Produto de stock | Itens de stock ○ Available under request | Disponível sobre consulta | Disponible bajo consulta

Note: Order Code = (1) + (2)
See page E - 694 for more detail information

ROUND (DIN 20400) | DIN 20400:1990

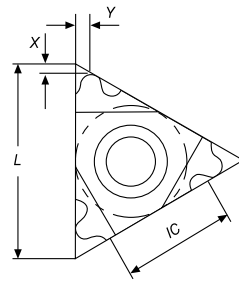
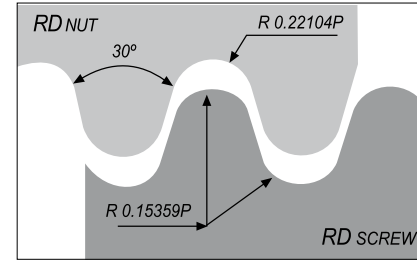

External

Geometry code (1) Código	Reference Referência Referencia	Pitch MM	Dimensions Dimensões Dimensiones (mm)				Stock - Grade Code (2)	
			IC	L	X	Y	(68) PH6920	(D0) PH8920
1882347	22 ER 4.0 RD20400	4.0	12.70	22	1.4	1.4	☉	○
1882348	22 ER 5.0 RD20400	5.0	12.70	22	1.7	1.8	○	○
1882349	22 ER 6.0 RD20400	6.0	12.70	22	1.7	2.0	○	○
1882351	22 EL 4.0 RD20400	4.0	12.70	22	1.4	1.4	○	○
1882352	22 EL 5.0 RD20400	5.0	12.70	22	1.7	1.8	○	○
1882353	22 EL 6.0 RD20400	6.0	12.70	22	1.7	2.0	○	○

☉ Stock item | Produto de stock | Itens de stock

○ Available under request | Disponível sobre consulta | Disponible bajo consulta

Note: Order Code = (1) + (2)
See page E - 694 for more detail information

Internal

Geometry code (1) Código	Reference Referência Referencia	Pitch MM	Dimensions Dimensões Dimensiones (mm)				Stock - Grade Code (2)	
			IC	L	X	Y	(68) PH6920	(D0) PH8920
1882355	22 IR 4.0 RD20400	4.0	12.70	22	1.4	1.4	○	○
1882356	22 IR 5.0 RD20400	5.0	12.70	22	1.7	1.8	○	○
1882357	22 IR 6.0 RD20400	6.0	12.70	22	1.7	2.0	○	○
1882359	22 IL 4.0 RD20400	4.0	12.70	22	1.4	1.4	○	○
1882360	22 IL 5.0 RD20400	5.0	12.70	22	1.7	1.8	○	○
1882361	22 IL 6.0 RD20400	6.0	12.70	22	1.7	2.0	○	○

☉ Stock item | Produto de stock | Itens de stock

○ Available under request | Disponível sobre consulta | Disponible bajo consulta

Note: Order Code = (1) + (2)
See page E - 694 for more detail information

TRAPEZ | DIN 103:1977 | ISO 2901:1993

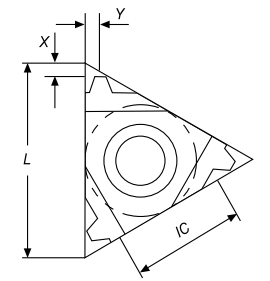
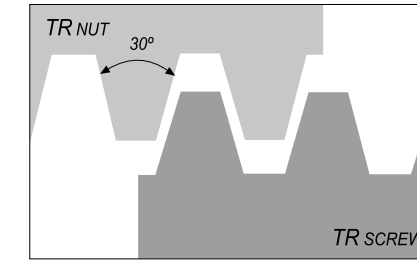
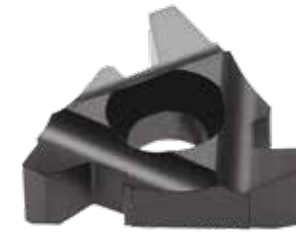

External

Geometry code (1) Código	Reference Referência Referencia	Pitch MM	Dimensions Dimensões Dimensiones (mm)				Stock - Grade Code (2)	
			IC	L	X	Y	(68) PH6920	(D0) PH8920
1881044	16 ER 1.5 TR	1.5	9.525	16	1.0	1.1	○	○
1881045	16 ER 2.0 TR	2.0	9.525	16	1.0	1.3	☉	○
1881046	16 ER 3.0 TR	3.0	9.525	16	1.3	1.5	☉	○
1883778	16 ER 4.0 TR	4.0	9.525	16	1.3	1.5	○	○
1881047	22 ER 4.0 TR	4.0	12.70	22	1.8	1.9	○	○
1881049	22 ER 5.0 TR	5.0	12.70	22	2.0	2.4	☉	○
1883779	22 ER 6.0 TR	6.0	12.70	22	2.0	2.4	○	○
1882165	27 ER 6.0 TR	6.0	15.875	27	2.3	2.7	○	○
1882166	27 ER 7.0 TR	7.0	15.875	27	2.2	2.6	○	○
1881050	16 EL 1.5 TR	1.5	9.525	16	1.0	1.1	○	○
1881051	16 EL 2.0 TR	2.0	9.525	16	1.1	1.3	○	○
1881052	16 EL 3.0 TR	3.0	9.525	16	1.3	1.5	○	○
1883780	16 EL 4.0 TR	4.0	9.525	16	1.3	1.5	○	○
1881053	22 EL 4.0 TR	4.0	12.70	22	1.8	1.9	○	○
1882130	22 EL 5.0 TR	5.0	12.70	22	2.0	2.4	○	○
1883781	22 EL 6.0 TR	6.0	12.70	22	2.0	2.4	○	○
1882152	27 EL 6.0 TR	6.0	15.875	27	2.3	2.7	○	○
1882153	27 EL 7.0 TR	7.0	15.875	27	2.2	2.6	○	○

☉ Stock item | Produto de stock | Itens de stock

○ Available under request | Disponível sobre consulta | Disponible bajo consulta

Note: Order Code = (1) + (2)
See page E - 694 for more detail information

Internal

Geometry code (1) Código	Reference Referência Referencia	Pitch MM	Dimensions Dimensões Dimensiones (mm)				Stock - Grade Code (2)	
			IC	L	X	Y	(68) PH6920	(D0) PH8920
1883782	08 IR 1.5 TR	1.5	5.00	08	0.6	0.6	○	○
1881055	16 IR 1.5 TR	1.5	9.525	16	1.0	1.1	○	○
1881056	16 IR 2.0 TR	2.0	9.525	16	1.0	1.3	○	○
1881057	16 IR 3.0 TR	3.0	9.525	16	1.3	1.5	○	○
1882119	16 IR 4.0 TR	4.0	9.525	16	1.3	1.5	○	○
1881058	22 IR 4.0 TR	4.0	12.70	22	1.8	1.9	○	○
1881059	22 IR 5.0 TR	5.0	12.70	22	2.0	2.4	○	○
1881060	22 IR 6.0 TR	6.0	12.70	22	2.0	2.4	⊗	○
1882187	27 IR 6.0 TR	6.0	15.875	27	2.3	2.7	○	○
1882188	27 IR 7.0 TR	7.0	15.875	27	2.2	2.6	○	○
1883783	08 IL 1.5 TR	1.5	5.00	08	0.6	0.6	○	○
1881062	16 IL 2.0 TR	2.0	9.525	16	1.0	1.3	○	○
1881063	16 IL 3.0 TR	3.0	9.525	16	1.3	1.5	○	○
1882093	16 IL 4.0 TR	4.0	9.525	16	1.3	1.5	○	○
1881064	22 IL 4.0 TR	4.0	12.70	22	1.8	1.9	○	○
1881065	22 IL 5.0 TR	5.0	12.70	22	2.0	2.4	○	○
1881066	22 IL 6.0 TR	6.0	12.70	22	2.0	2.4	○	○
1882176	27 IL 6.0 TR	6.0	15.875	27	2.3	2.7	○	○
1882177	27 IL 7.0 TR	7.0	15.875	27	2.2	2.6	○	○

⊗ Stock item | Produto de stock | Itens de stock ○ Available under request | Disponível sobre consulta | Disponible bajo consulta

Note: Order Code = (1) + (2)
See page E - 694 for more detail information

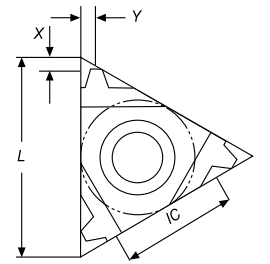
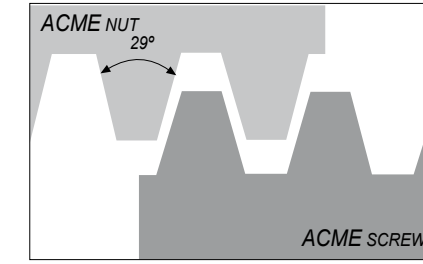
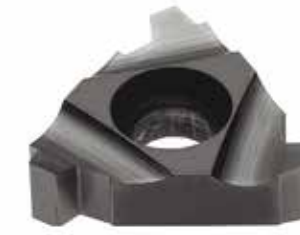

External

Geometry code (1) Código	Reference Referência Referencia	Pitch TPI	Dimensions Dimensões Dimensiones (mm)				Stock - Grade Code (2)	
			IC	L	X	Y	(68) PH6920	(D0) PH8920
1881871	11 ER 16 ACME	16	6.35	11	0.9	1.0	○	○
1881078	16 ER 16 ACME	16	9.525	16	0.9	1.0	⊗	○
1881077	16 ER 14 ACME	14	9.525	16	1.0	1.2	○	○
1881076	16 ER 12 ACME	12	9.525	16	1.1	1.2	○	○
1881075	16 ER 10 ACME	10	9.525	16	1.3	1.3	⊗	○
1881079	16 ER 8 ACME	8	9.525	16	1.5	1.5	○	○
1883784	16 ER 6 ACME	6	9.525	16	1.7	1.8	○	○
1881080	22 ER 6 ACME	6	12.70	22	1.8	2.1	⊗	○
1881081	22 ER 5 ACME	5	12.70	22	2.0	2.3	○	○
1883826	22 ER 4 ACME	4	12.70	22	2.1	2.2	○	○
1882159	27 ER 4 ACME	4	15.875	27	2.3	2.7	○	○
1881813	11 EL 16 ACME	16	6.35	11	0.9	1.0	○	○
1881997	16 EL 16 ACME	16	9.525	16	0.9	1.0	○	○
1881992	16 EL 14 ACME	14	9.525	16	1.0	1.2	○	○
1881990	16 EL 12 ACME	12	9.525	16	1.1	1.2	○	○
1881985	16 EL 10 ACME	10	9.525	16	1.3	1.3	○	○
1882024	16 EL 8 ACME	8	9.525	16	1.5	1.5	○	○
1883827	16 EL 6 ACME	6	9.525	16	1.7	1.8	○	○
1882133	22 EL 6 ACME	6	12.70	22	1.8	2.1	○	○
1882131	22 EL 5 ACME	5	12.70	22	2.0	2.3	○	○
1883785	22 EL 4 ACME	4	12.70	22	2.1	2.2	○	○
1882146	27 EL 4 ACME	4	15.875	27	2.3	2.7	○	○

⊗ Stock item | Produto de stock | Itens de stock ○ Available under request | Disponível sobre consulta | Disponible bajo consulta

Note: Order Code = (1) + (2)
See page E - 694 for more detail information

Internal

Geometry code (1) Código	Reference Referência Referencia	Pitch TPI	Dimensions Dimensões Dimensiones (mm)				Stock - Grade Code (2)	
			IC	L	X	Y	(68) PH6920	(D0) PH8920
1883786	08 IR 16 ACME	16	5.00	08	0.6	0.6	○	○
1881944	11 IR 16 ACME	16	6.35	11	0.9	1.0	○	○
1881107	16 IR 16 ACME	16	9.525	0.9	1.0	1.1	⊗	○
1881106	16 IR 14 ACME	14	9.525	1.0	1.2	1.2	○	○
1881105	16 IR 12 ACME	12	9.525	1.1	1.2	1.2	○	○
1881104	16 IR 10 ACME	10	9.525	1.3	1.3	1.4	○	○
1881103	16 IR 8 ACME	8	9.525	1.5	1.5	1.5	○	○
1881885	16 IR 6 ACME	6	9.525	1.7	1.8	1.5	○	○
1881083	22 IR 6 ACME	6	12.70	22	1.8	2.1	⊗	○
1881082	22 IR 5 ACME	5	12.70	22	2.0	2.3	○	○
1881102	22 IR 4 ACME	4	12.70	22	2.1	2.2	⊗	○
1882182	27 IR 4 ACME	4	15.875	27	2.3	2.7	○	○
1883787	08 IL 16 ACME	16	5.00	08	0.6	0.6	○	○
1881921	11 IL 16 ACME	16	6.35	11	0.9	1.0	○	○
1882080	16 IL 16 ACME	16	9.525	0.9	1.0	1.1	○	○
1882075	16 IL 14 ACME	14	9.525	1.0	1.2	1.2	○	○
1882072	16 IL 12 ACME	12	9.525	1.1	1.2	1.2	○	○
1882067	16 IL 10 ACME	10	9.525	1.3	1.3	1.4	○	○
1882102	16 IL 8 ACME	8	9.525	1.5	1.5	1.5	○	○
1882099	16 IL 6 ACME	6	9.525	1.7	1.8	1.5	○	○
1882140	22 IL 6 ACME	6	12.70	22	1.8	2.1	○	○
1882138	22 IL 5 ACME	5	12.70	22	2.0	2.3	○	○
1882136	22 IL 4 ACME	4	12.70	22	2.1	2.2	○	○
1882171	27 IL 4 ACME	4	15.875	27	2.3	2.7	○	○

⊗ Stock item | Produto de stock | Itens de stock

○ Available under request | Disponível sobre consulta | Disponible bajo consulta

Note: Order Code = (1) + (2)
See page E - 694 for more detail information

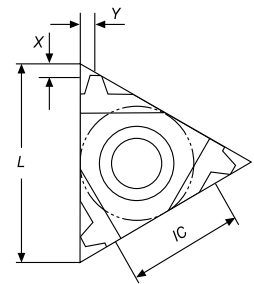
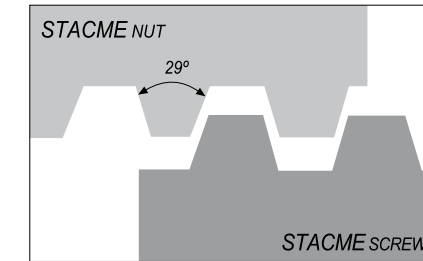

External

Geometry code (1) Código	Reference Referência Referencia	Pitch TPI	Dimensions Dimensões Dimensiones (mm)				Stock - Grade Code (2)	
			IC	L	X	Y	(68) PH6920	(D0) PH8920
1881872	11 ER 16 STACME	16	6.35	11	1.0	1.0	○	○
1881116	16 ER 16 STACME	16	9.525	16	1.0	1.0	○	○
1881117	16 ER 14 STACME	14	9.525	16	1.1	1.1	○	○
1881118	16 ER 12 STACME	12	9.525	16	1.2	1.2	○	○
1881119	16 ER 10 STACME	10	9.525	16	1.3	1.3	○	○
1881120	16 ER 8 STACME	8	9.525	16	1.5	1.5	○	○
1881121	16 ER 6 STACME	6	9.525	16	1.8	1.8	⊗	○
1882135	22 ER 6 STACME	6	12.70	22	1.8	2.1	○	○
1881122	22 ER 5 STACME	5	12.70	22	2.0	2.3	○	○
1881123	22 ER 4 STACME	4	12.70	22	2.3	2.4	○	○
1882160	27 ER 4 STACME	4	15.875	27	2.3	2.4	⊗	○
1882156	27 ER 3 STACME	3	15.875	27	2.8	2.9	○	○
1881814	11 EL 16 STACME	16	6.35	11	1.0	1.0	○	○
1881998	16 EL 16 STACME	16	9.525	16	1.0	1.0	○	○
1881996	16 EL 14 STACME	14	9.525	16	1.1	1.1	○	○
1881991	16 EL 12 STACME	12	9.525	16	1.2	1.2	○	○
1881986	16 EL 10 STACME	10	9.525	16	1.3	1.3	○	○
1882027	16 EL 8 STACME	8	9.525	16	1.5	1.5	○	○
1882021	16 EL 6 STACME	6	9.525	16	1.8	1.8	○	○
1882134	22 EL 6 STACME	6	12.70	22	1.8	2.1	○	○
1882132	22 EL 5 STACME	5	12.70	22	2.0	2.3	○	○
1881889	22 EL 4 STACME	4	12.70	22	2.3	2.4	○	○
1882147	27 EL 4 STACME	4	15.875	27	2.3	2.4	○	○
1882143	27 EL 3 STACME	3	15.875	27	2.8	2.9	○	○

⊗ Stock item | Produto de stock | Itens de stock

○ Available under request | Disponível sobre consulta | Disponible bajo consulta

Note: Order Code = (1) + (2)
See page E - 694 for more detail information

Internal

Geometry code (1) Código	Reference Referência Referencia	Pitch TPI	Dimensions Dimensões Dimensiones (mm)				Stock - Grade Code (2)	
			IC	L	X	Y	(68) PH6920	(D0) PH8920
1883788	08 IR 16 STACME	16	5.00	08	0.6	0.6	○	○
1881108	16 IR 16 STACME	16	9.525	16	1.0	1.0	○	○
1881109	16 IR 14 STACME	14	9.525	16	1.1	1.1	○	○
1881110	16 IR 12 STACME	12	9.525	16	1.2	1.2	○	○
1881111	16 IR 10 STACME	10	9.525	16	1.3	1.3	○	○
1881112	16 IR 8 STACME	8	9.525	16	1.5	1.5	○	○
1881113	16 IR 6 STACME	6	9.525	16	1.8	1.8	○	○
1882142	22 IR 6 STACME	6	12.70	22	1.8	2.1	○	○
1881114	22 IR 5 STACME	5	12.70	22	2.0	2.3	○	○
1881115	22 IR 4 STACME	4	12.70	22	2.3	2.4	○	○
1882183	27 IR 4 STACME	4	15.875	27	2.3	2.4	⊗	○
1882180	27 IR 3 STACME	3	15.875	27	2.8	2.9	○	○
1883789	08 IL 16 STACME	16	5.00	08	0.6	0.6	○	○
1882081	16 IL 16 STACME	16	9.525	16	1.0	1.0	○	○
1882079	16 IL 14 STACME	14	9.525	16	1.1	1.1	○	○
1882073	16 IL 12 STACME	12	9.525	16	1.2	1.2	○	○
1882068	16 IL 10 STACME	10	9.525	16	1.3	1.3	○	○
1882105	16 IL 8 STACME	8	9.525	16	1.5	1.5	○	○
1882100	16 IL 6 STACME	6	9.525	16	1.8	1.8	○	○
1882141	22 IL 6 STACME	6	12.70	22	1.8	2.1	○	○
1882139	22 IL 5 STACME	5	12.70	22	2.0	2.3	○	○
1882137	22 IL 4 STACME	4	12.70	22	2.3	2.4	○	○
1882172	27 IL 4 STACME	4	15.875	27	2.3	2.4	○	○
1882169	27 IL 3 STACME	3	15.875	27	2.8	2.9	○	○

⊗ Stock item | Produto de stock | Itens de stock

○ Available under request | Disponível sobre consulta | Disponible bajo consulta

Note: Order Code = (1) + (2)
See page E - 694 for more detail information

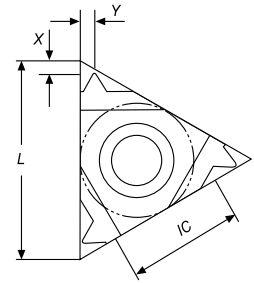
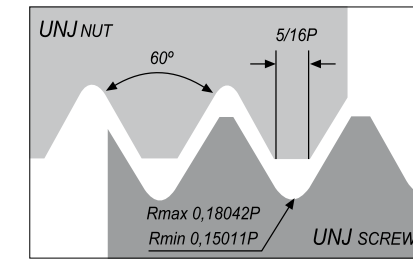

External

Geometry code (1) Código	Reference Referência Referencia	Pitch TPI	Dimensions Dimensões Dimensiones (mm)				Stock - Grade Code (2)	
			IC	L	X	Y	(68) PH6920	(D0) PH8920
1883790	11 ER 48 UNJ	48	6.35	11	0.6	0.6	○	○
1883791	11 ER 44 UNJ	44	6.35	11	0.6	0.6	○	○
1883792	11 ER 40 UNJ	40	6.35	11	0.6	0.6	○	○
1883793	11 ER 36 UNJ	36	6.35	11	0.6	0.6	○	○
1882318	11 ER 32 UNJ	32	6.35	11	0.6	0.6	○	○
1882319	11 ER 28 UNJ	28	6.35	11	0.6	0.6	○	○
1882320	11 ER 24 UNJ	24	6.35	11	0.7	0.8	○	○
1882321	11 ER 20 UNJ	20	6.35	11	0.8	0.9	○	○
1882322	11 ER 18 UNJ	18	6.35	11	0.8	1.0	○	○
1882323	11 ER 16 UNJ	16	6.35	11	0.8	1.0	○	○
1882324	11 ER 14 UNJ	14	6.35	11	0.9	1.0	○	○
1883794	16 ER 48 UNJ	48	9.525	16	0.6	0.6	○	○
1883795	16 ER 44 UNJ	44	9.525	16	0.6	0.6	○	○
1883796	16 ER 40 UNJ	40	9.525	16	0.6	0.6	○	○
1883797	16 ER 36 UNJ	36	9.525	16	0.6	0.6	○	○
1881165	16 ER 32 UNJ	32	9.525	16	0.6	0.6	○	○
1881164	16 ER 28 UNJ	28	9.525	16	0.6	0.6	○	○
1881163	16 ER 24 UNJ	24	9.525	16	0.7	0.8	○	○
1881162	16 ER 20 UNJ	20	9.525	16	0.8	0.9	○	○
1881161	16 ER 18 UNJ	18	9.525	16	0.8	1.0	○	○
1881160	16 ER 16 UNJ	16	9.525	16	0.8	1.0	○	○
1881159	16 ER 14 UNJ	14	9.525	16	1.0	1.2	○	○
1881158	16 ER 13 UNJ	13	9.525	16	1.0	1.3	○	○
1881157	16 ER 12 UNJ	12	9.525	16	1.1	1.4	○	○
1881156	16 ER 11 UNJ	11	9.525	16	1.1	1.5	○	○
1881155	16 ER 10 UNJ	10	9.525	16	1.1	1.5	○	○
1881154	16 ER 9 UNJ	9	9.525	16	1.2	1.6	○	○
1881153	16 ER 8 UNJ	8	9.525	16	1.2	1.6	○	○
1883798	11 EL 48 UNJ	48	6.35	11	0.6	0.6	○	○
1883799	11 EL 44 UNJ	44	6.35	11	0.6	0.6	○	○
1883800	11 EL 40 UNJ	40	6.35	11	0.6	0.6	○	○
1883801	11 EL 36 UNJ	36	6.35	11	0.6	0.6	○	○
1882325	11 EL 32 UNJ	32	6.35	11	0.6	0.6	○	○
1882326	11 EL 28 UNJ	28	6.35	11	0.6	0.6	○	○
1882327	11 EL 24 UNJ	24	6.35	11	0.7	0.8	○	○
1882328	11 EL 20 UNJ	20	6.35	11	0.8	0.9	○	○

⊗ Stock item | Produto de stock | Itens de stock

○ Available under request | Disponível sobre consulta | Disponible bajo consulta

Note: Order Code = (1) + (2)
See page E - 694 for more detail information

External

Geometry code (1) Código	Reference Referência Referencia	Pitch TPI	Dimensions Dimensões Dimensiones (mm)				Stock - Grade Code (2)	
			IC	L	X	Y	(68) PH6920	(D0) PH8920
1882329	11 EL 18 UNJ	18	6.35	11	0.8	1.0	○	○
1882330	11 EL 16 UNJ	16	6.35	11	0.8	1.0	○	○
1882331	11 EL 14 UNJ	14	6.35	11	0.9	1.0	○	○
1883802	16 ER 48 UNJ	48	9.525	16	0.6	0.6	○	○
1883803	16 ER 44 UNJ	44	9.525	16	0.6	0.6	○	○
1883804	16 ER 40 UNJ	40	9.525	16	0.6	0.6	○	○
1883805	16 ER 36 UNJ	36	9.525	16	0.6	0.6	○	○
1881179	16 EL 32 UNJ	32	9.525	16	0.6	0.6	○	○
1881178	16 EL 28 UNJ	28	9.525	16	0.6	0.6	○	○
1881177	16 EL 24 UNJ	24	9.525	16	0.7	0.8	○	○
1881176	16 EL 20 UNJ	20	9.525	16	0.8	0.9	○	○
1881175	16 EL 18 UNJ	18	9.525	16	0.8	1.0	○	○
1881174	16 EL 16 UNJ	16	9.525	16	0.8	1.0	○	○
1881173	16 EL 14 UNJ	14	9.525	16	1.0	1.2	○	○
1881172	16 EL 13 UNJ	13	9.525	16	1.0	1.3	○	○
1881170	16 EL 12 UNJ	12	9.525	16	1.1	1.4	○	○
1881169	16 EL 11 UNJ	11	9.525	16	1.1	1.5	○	○
1881168	16 EL 10 UNJ	10	9.525	16	1.1	1.5	○	○
1881167	16 EL 9 UNJ	9	9.525	16	1.2	1.6	○	○
1881166	16 EL 8 UNJ	8	9.525	16	1.2	1.6	○	○

Stock item | Produto de stock | Itens de stock Available under request | Disponível sobre consulta | Disponible bajo consulta

Note: Order Code = (1) + (2)
See page E - 694 for more detail information

Internal

Geometry code (1) Código	Reference Referência Referencia	Pitch TPI	Dimensions Dimensões Dimensiones (mm)				Stock - Grade Code (2)	
			IC	L	X	Y	(68) PH6920	(D0) PH8920
1883806	11 IR 48 UNJ	48	6.35	11	0.6	0.6	○	○
1883807	11 IR 44 UNJ	44	6.35	11	0.6	0.6	○	○
1883808	11 IR 40 UNJ	40	6.35	11	0.6	0.6	○	○
1883809	11 IR 36 UNJ	36	6.35	11	0.6	0.6	○	○
1881198	11 IR 32 UNJ	32	6.35	11	0.6	0.6	○	○
1881197	11 IR 28 UNJ	28	6.35	11	0.6	0.6	○	○
1881196	11 IR 24 UNJ	24	6.35	11	0.7	0.8	○	○
1881195	11 IR 20 UNJ	20	6.35	11	0.8	0.9	○	○
1881194	11 IR 18 UNJ	18	6.35	11	0.8	1.0	○	○
1881193	11 IR 16 UNJ	16	6.35	11	0.8	1.0	○	○
1881192	11 IR 14 UNJ	14	6.35	11	0.9	1.0	○	○
1883810	16 IR 48 UNJ	48	9.525	16	0.6	0.6	○	○
1883811	16 IR 44 UNJ	44	9.525	16	0.6	0.6	○	○
1883812	16 IR 40 UNJ	40	9.525	16	0.6	0.6	○	○
1883813	16 IR 36 UNJ	36	9.525	16	0.6	0.6	○	○
1881191	16 IR 32 UNJ	32	9.525	16	0.6	0.6	○	○
1881190	16 IR 28 UNJ	28	9.525	16	0.6	0.6	○	○
1881189	16 IR 24 UNJ	24	9.525	16	0.7	0.8	○	○
1881188	16 IR 20 UNJ	20	9.525	16	0.8	0.9	○	○
1881187	16 IR 18 UNJ	18	9.525	16	0.8	1.0	○	○
1881186	16 IR 16 UNJ	16	9.525	16	0.8	1.0	○	○
1881185	16 IR 14 UNJ	14	9.525	16	1.0	1.2	○	○
1883814	16 IR 13 UNJ	13	9.525	16	1.0	1.3	○	○
1881184	16 IR 12 UNJ	12	9.525	16	1.1	1.4	⊗	○
1881183	16 IR 11 UNJ	11	9.525	16	1.1	1.5	○	○
1881182	16 IR 10 UNJ	10	9.525	16	1.1	1.5	⊗	○
1881181	16 IR 9 UNJ	9	9.525	16	1.2	1.6	○	○
1881180	16 IR 8 UNJ	8	9.525	16	1.2	1.6	○	○
1883815	11 IL 48 UNJ	48	6.35	11	0.6	0.6	○	○
1883816	11 IL 44 UNJ	44	6.35	11	0.6	0.6	○	○
1883817	11 IL 40 UNJ	40	6.35	11	0.6	0.6	○	○
1883818	11 IL 36 UNJ	36	6.35	11	0.6	0.6	○	○
1881217	11 IL 32 UNJ	32	6.35	11	0.6	0.6	○	○
1881216	11 IL 28 UNJ	28	6.35	11	0.6	0.6	○	○
1881215	11 IL 24 UNJ	24	6.35	11	0.7	0.8	○	○
1881214	11 IL 20 UNJ	20	6.35	11	0.8	0.9	○	○
1881213	11 IL 18 UNJ	18	6.35	11	0.8	1.0	○	○
1881188	11 IL 16 UNJ	16	6.35	11	0.8	1.0	○	○
1881211	11 IL 14 UNJ	14	6.35	11	0.9	1.0	○	○
1883819	16 IL 48 UNJ	48	9.525	16	0.6	0.6	⊗	○
1883820	16 IL 44 UNJ	44	9.525	16	0.6	0.6	⊗	○
1883821	16 IL 40 UNJ	40	9.525	16	0.6	0.6	○	○
1883822	16 IL 36 UNJ	36	9.525	16	0.6	0.6	○	○
1881210	16 IL 32 UNJ	32	9.525	16	0.6	0.6	⊗	○
1881209	16 IL 28 UNJ	28	9.525	16	0.6	0.6	○	○
1881208	16 IL 24 UNJ	24	9.525	16	0.7	0.8	⊗	○

Stock item | Produto de stock | Itens de stock Available under request | Disponível sobre consulta | Disponible bajo consulta

Note: Order Code = (1) + (2)
See page E - 694 for more detail information

Internal

Geometry code (1) Código	Reference Referência Referencia	Pitch	Dimensions Dimensões Dimensiones (mm)				Stock - Grade Code (2)	
		TPI	IC	L	X	Y	(68) PH6920	(D0) PH8920
1881207	16 IL 20 UNJ	20	9.525	16	0.8	0.9	○	○
1881206	16 IL 18 UNJ	18	9.525	16	0.8	1.0	○	○
1881205	16 IL 16 UNJ	16	9.525	16	0.8	1.0	○	○
1881204	16 IL 14 UNJ	14	9.525	16	1.0	1.2	○	○
1883823	16 IR 13 UNJ	13	9.525	16	1.0	1.3	○	○
1881203	16 IL 12 UNJ	12	9.525	16	1.1	1.4	○	○
1881202	16 IL 11 UNJ	11	9.525	16	1.1	1.5	○	○
1881201	16 IL 10 UNJ	10	9.525	16	1.1	1.5	○	○
1881200	16 IL 9 UNJ	9	9.525	16	1.2	1.6	○	○
1881199	16 IL 8 UNJ	8	9.525	16	1.2	1.6	○	○

Stock item | Produto de stock | Itens de stock

Available under request | Disponível sobre consulta | Disponible bajo consulta

Note: Order Code = (1) + (2)
See page E - 694 for more detail information

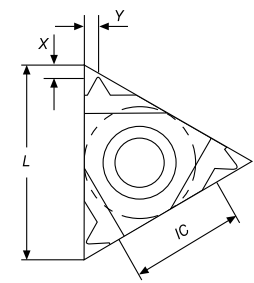
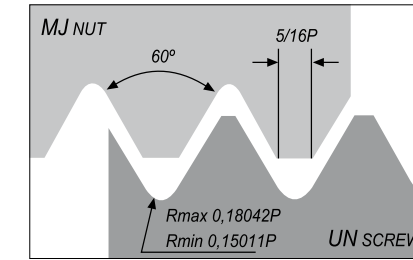

External

Geometry code (1) Código	Reference Referência Referencia	Pitch	Dimensions Dimensões Dimensiones (mm)				Stock - Grade Code (2)	
		TPI	IC	L	X	Y	(68) PH6920	(D0) PH8920
1881067	16 ER 1.0 MJ	1.0	9.525	16	0.7	0.8	○	○
1881068	16 ER 1.25 MJ	1.25	9.525	16	0.8	0.9	○	○
1881069	16 ER 1.5 MJ	1.5	9.525	16	0.8	1.0	○	○
1881070	16 ER 2.0 MJ	2.0	9.525	16	1.0	1.3	⊗	○

Stock item | Produto de stock | Itens de stock

Available under request | Disponível sobre consulta | Disponible bajo consulta

Note: Order Code = (1) + (2)
See page E - 694 for more detail information

Internal

Geometry code (1) Código	Reference Referência Referencia	Pitch	Dimensions Dimensões Dimensiones (mm)				Stock - Grade Code (2)	
		TPI	IC	L	X	Y	(68) PH6920	(D0) PH8920
1882370	11 IR 1.0 MJ	1.0	6.35	11	0.7	0.8	○	○
1882371	11 IR 1.25 MJ	1.25	6.35	11	0.8	0.9	○	○
1882372	11 IR 1.5 MJ	1.5	6.35	11	0.8	1.0	○	○
1883824	11 IR 2.0 MJ	2.0	6.35	11	0.9	1.0	○	○
1881071	16 IR 1.0 MJ	1.0	9.525	16	0.7	0.8	○	○
1881072	16 IR 1.25 MJ	1.25	9.525	16	0.8	0.9	○	○
1881073	16 IR 1.5 MJ	1.5	9.525	16	0.8	1.0	○	○
1881074	16 IR 2.0 MJ	2.0	9.525	16	1.0	1.3	○	○

Stock item | Produto de stock | Itens de stock

Available under request | Disponível sobre consulta | Disponible bajo consulta

Note: Order Code = (1) + (2)
See page E - 694 for more detail information

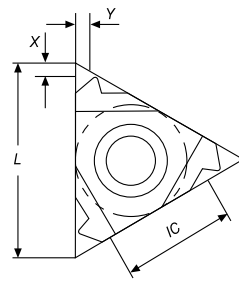
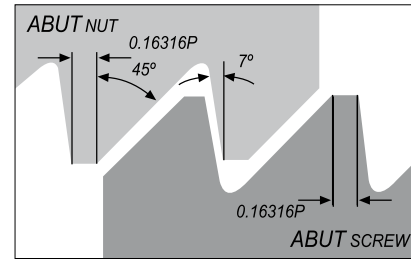

External

Geometry code (1) Código	Reference Referência Referencia	Pitch	Dimensions Dimensões Dimensiones (mm)				Stock - Grade Code (2)	
		TPI	IC	L	X	Y	(68) PH6920	(D0) PH8920
1882298	11 ER 20 ABUT	20	6.35	11	1.0	1.3	○	○
1882299	11 ER 16 ABUT	16	6.35	11	1.0	1.5	○	○
1881007	16 ER 20 ABUT	20	9.525	16	1.0	1.3	○	○
1880754	16 ER 16 ABUT	16	9.525	16	1.0	1.5	○	○
1881006	16 ER 12 ABUT	12	9.525	16	1.4	2.0	○	○
1881005	16 ER 10 ABUT	10	9.525	16	1.5	2.3	○	○
1881008	22 ER 8 ABUT	8	12.70	22	2.1	3.3	○	○
1881009	22 ER 6 ABUT	6	12.70	22	2.1	3.4	○	○
1882300	11 EL 20 ABUT	20	6.35	11	1.0	1.4	○	○
1882301	11 EL 16 ABUT	16	6.35	11	1.1	1.6	○	○
1882302	16 EL 20 ABUT	20	9.525	16	1.0	1.3	○	○
1882303	16 EL 16 ABUT	16	9.525	16	1.0	1.5	○	○
1882304	16 EL 12 ABUT	12	9.525	16	1.4	2.0	○	○
1882305	16 EL 10 ABUT	10	9.525	16	1.5	2.3	○	○
1882306	22 EL 8 ABUT	8	12.70	22	2.1	3.3	○	○
1882307	22 EL 6 ABUT	6	12.70	22	2.1	3.4	○	○

Stock item | Produto de stock | Itens de stock
 Available under request | Disponível sobre consulta | Disponible bajo consulta

Note: Order Code = (1) + (2)
See page E - 694 for more detail information

Internal

Geometry code (1) Código	Reference Referência Referencia	Pitch	Dimensions Dimensões Dimensiones (mm)				Stock - Grade Code (2)	
		TPI	IC	L	X	Y	(68) PH6920	(D0) PH8920
1882308	11 IR 20 ABUT	20	6.35	11	1.0	1.4	○	○
1882309	11 IR 16 ABUT	16	6.35	11	1.1	1.6	○	○
1881015	16 IR 20 ABUT	20	9.525	16	1.0	1.3	○	○
1881014	16 IR 16 ABUT	16	9.525	16	1.0	1.5	⊗	○
1881013	16 IR 12 ABUT	12	9.525	16	1.4	2.0	○	○
1881012	16 IR 10 ABUT	10	9.525	16	1.5	2.3	○	○
1881011	22 IR 8 ABUT	8	12.70	22	2.1	3.3	○	○
1881010	22 IR 6 ABUT	6	12.70	22	2.1	3.4	○	○
1882310	11 IL 20 ABUT	20	6.35	11	1.0	1.4	○	○
1882311	11 IL 16 ABUT	16	6.35	11	1.1	1.6	○	○
1882312	16 IL 20 ABUT	20	9.525	16	1.0	1.3	○	○
1882313	16 IL 16 ABUT	16	9.525	16	1.0	1.5	○	○
1882314	16 IL 12 ABUT	12	9.525	16	1.4	2.0	○	○
1882315	16 IL 10 ABUT	10	9.525	16	1.5	2.3	○	○
1882316	22 IL 8 ABUT	8	12.70	22	2.1	3.3	○	○
1882317	22 IL 6 ABUT	6	12.70	22	2.1	3.4	○	○

Stock item | Produto de stock | Itens de stock
 Available under request | Disponível sobre consulta | Disponible bajo consulta

Note: Order Code = (1) + (2)
See page E - 694 for more detail information

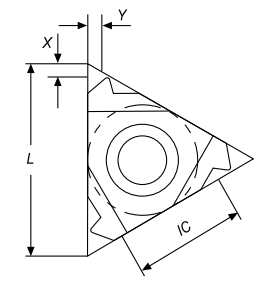
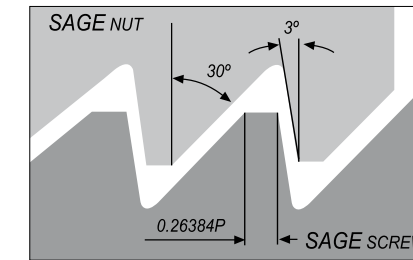

External

Geometry code (1) Código	Reference Referência Referencia	Pitch	Dimensions Dimensões Dimensiones (mm)				Stock - Grade Code (2)	
		TPI	IC	L	X	Y	(68) PH6920	(D0) PH8920
1882384	16 ER 2.0 SAGE	2.0	9.525	16	1.1	1.6	○	○
1882385	22 ER 3.0 SAGE	3.0	12.70	22	1.5	2.4	○	○
1882386	22 ER 4.0 SAGE	4.0	12.70	22	1.9	3.1	⊗	○
1882387	16 EL 2.0 SAGE	2.0	9.525	16	1.1	1.6	○	○
1882388	22 EL 3.0 SAGE	3.0	12.70	22	1.5	2.4	○	○
1882389	22 EL 4.0 SAGE	4.0	12.70	22	1.9	3.1	○	○

Stock item | Produto de stock | Itens de stock
 Available under request | Disponível sobre consulta | Disponible bajo consulta

Note: Order Code = (1) + (2)
See page E - 694 for more detail information

Internal

Geometry code (1) Código	Reference Referência Referencia	Pitch	Dimensions Dimensões Dimensiones (mm)				Stock - Grade Code (2)	
		TPI	IC	L	X	Y	(68) PH6920	(D0) PH8920
1882390	16 IR 2.0 SAGE	2.0	9.525	16	1.2	1.7	○	○
1882391	22 IR 3.0 SAGE	3.0	12.70	22	1.9	2.9	○	○
1882392	22 IR 4.0 SAGE	4.0	12.70	22	2.3	3.5	○	○
1882393	16 IL 2.0 SAGE	2.0	9.525	16	1.2	1.7	○	○
1882394	22 IL 3.0 SAGE	3.0	12.70	22	1.9	2.9	○	○
1882395	22 IL 4.0 SAGE	4.0	12.70	22	2.3	3.5	○	○

Stock item | Produto de stock | Itens de stock
 Available under request | Disponível sobre consulta | Disponible bajo consulta

Note: Order Code = (1) + (2)
See page E - 694 for more detail information

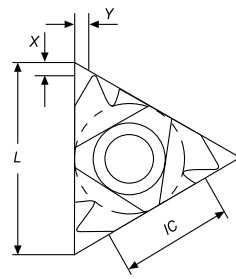
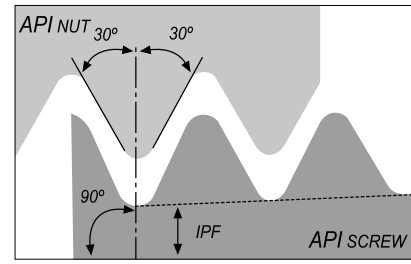
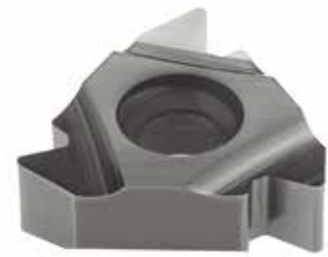

External

Geometry code (1) Código	Reference Referência Referencia	Pitch TPI	Thread	Taper IPF	Size	Dimensions Dimensões Dimensiones (mm)				Stock - Grade Code (2)	
						IC	L	X	Y	(68) PH6920	(D0) PH8920
1881326	22 ER 5.00 API 403	5	V-0.040	3	2 3/8" - 4 1/2" REG	12.70	22	1.8	2.5	☉	○
1881322	22 ER 4.00 API 382	4	V-0.038R	2	NC23-NC50	12.70	22	2.0	2.6	○	○
1881324	22 ER 4.00 API 502	4	V-0.050	2	6 5/8" REG	12.70	22	1.9	2.8	○	○
1882396	27 ER 5.00 API 403	5	V-0.040	3	2 3/8" - 4 1/2" REG	15.875	27	1.9	2.7	○	○
1882397	27 ER 4.00 API 382	4	V-0.038R	2	NC23-NC50	15.875	27	2.1	2.8	○	○
1882398	27 ER 4.00 API 383	4	V-0.038R	3	NC56-NC77	15.875	27	2.1	2.8	○	○
1882399	27 ER 4.00 API 502	4	V-0.050	2	6 5/8" REG	15.875	27	2.0	3.0	☉	○
1882400	27 ER 4.00 API 503	4	V-0.050	3	5 1/2", 7 5/8", 8 5/8" REG	15.875	27	2.0	3.0	○	○

☉ Stock item | Produto de stock | Itens de stock ○ Available under request | Disponível sobre consulta | Disponible bajo consulta

Note: Order Code = (1) + (2)
See page E - 694 for more detail information

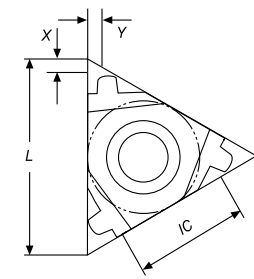
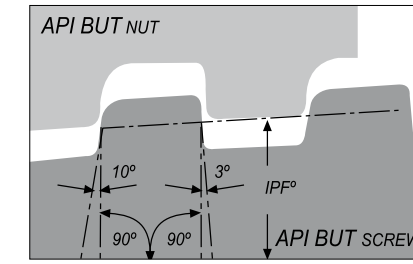

External

Geometry code (1) Código	Reference Referência Referencia	Pitch TPI	Taper IPF	Size	Dimensions Dimensões Dimensiones (mm)				Stock - Grade Code (2)	
					IC	L	X	Y	(68) PH6920	(D0) PH8920
1881327	22 ER 5 BUT 0.75	5	0.75	4 1/2" - 13 3/8"	12.70	22	2.2	2.4	☉	○
1881328	22 ER 5 BUT 1.00	5	1.00	16" - 20"	12.70	22	2.3	2.4	○	○

☉ Stock item | Produto de stock | Itens de stock ○ Available under request | Disponível sobre consulta | Disponible bajo consulta

Note: Order Code = (1) + (2)
See page E - 694 for more detail information

Internal

Geometry code (1) Código	Reference Referência Referencia	Pitch TPI	Taper IPF	Size	Dimensions Dimensões Dimensiones (mm)				Stock - Grade Code (2)	
					IC	L	X	Y	(68) PH6920	(D0) PH8920
1881336	22 IR 5 BUT 0.75	5	0.75	4 1/2" - 13 3/8"	12.70	22	2.2	2.4	☉	○
1881337	22 IR 5 BUT 1.00	5	1.00	16" - 20"	12.70	22	2.3	2.4	○	○

☉ Stock item | Produto de stock | Itens de stock ○ Available under request | Disponível sobre consulta | Disponible bajo consulta

Note: Order Code = (1) + (2)
See page E - 694 for more detail information

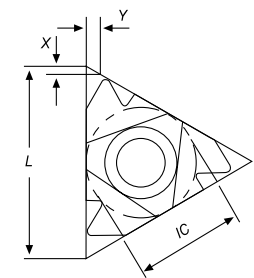
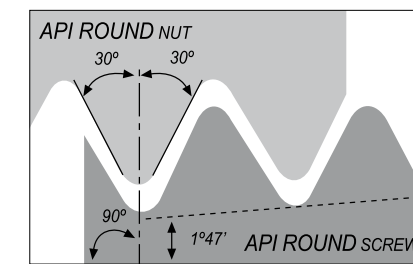

Internal

Geometry code (1) Código	Reference Referência Referencia	Pitch TPI	Thread	Taper IPF	Size	Dimensions Dimensões Dimensiones (mm)				Stock - Grade Code (2)	
						IC	L	X	Y	(68) PH6920	(D0) PH8920
1881335	22 IR 5.00 API 403	5	V-0.040	3	2 3/8" - 4 1/2" REG	12.70	22	1.8	2.5	☉	○
1881331	22 IR 4.00 API 382	4	V-0.038R	2	NC23-NC50	12.70	22	2.0	2.6	○	○
1881333	22 IR 4.00 API 502	4	V-0.050	2	6 5/8" REG	12.70	22	1.9	2.8	○	○
1882401	27 IR 5.00 API 403	5	V-0.040	3	2 3/8" - 4 1/2" REG	15.875	27	1.9	2.7	○	○
1882402	27 IR 4.00 API 382	4	V-0.038R	2	NC23-NC50	15.875	27	2.1	2.8	○	○
1882403	27 IR 4.00 API 383	4	V-0.038R	3	NC56-NC77	15.875	27	2.1	2.8	○	○
1882404	27 IR 4.00 API 502	4	V-0.050	2	6 5/8" REG	15.875	27	2.0	3.0	○	○
1882405	27 IR 4.00 API 503	4	V-0.050	3	5 1/2", 7 5/8", 8 5/8" REG	15.875	27	2.0	3.0	○	○

☉ Stock item | Produto de stock | Itens de stock ○ Available under request | Disponível sobre consulta | Disponible bajo consulta

Note: Order Code = (1) + (2)
See page E - 694 for more detail information

External

Geometry code (1) Código	Reference Referência Referencia	Pitch TPI	Taper IPF	Size	Dimensions Dimensões Dimensiones (mm)				Stock - Grade Code (2)	
					IC	L	X	Y	(68) PH6920	(D0) PH8920
1881318	16 ER 10 API RD	10	0.75	9.525	16	1.5	1.4	○	○	
1881320	16 ER 8 API RD	8	0.75	9.525	16	1.3	1.6	☉	○	

☉ Stock item | Produto de stock | Itens de stock ○ Available under request | Disponível sobre consulta | Disponible bajo consulta

Note: Order Code = (1) + (2)
See page E - 694 for more detail information

Internal

Geometry code (1) Código	Reference Referência Referencia	Pitch TPI	Taper IPF	Size	Dimensions Dimensões Dimensiones (mm)				Stock - Grade Code (2)	
					IC	L	X	Y	(68) PH6920	(D0) PH8920
1881319	16 IR 10 API RD	10	0.75	9.525	16	1.5	1.4	○	○	
1881321	16 IR 8 API RD	8	0.75	9.525	16	1.3	1.6	○	○	

☉ Stock item | Produto de stock | Itens de stock ○ Available under request | Disponível sobre consulta | Disponible bajo consulta

Note: Order Code = (1) + (2)
See page E - 694 for more detail information

THREADING

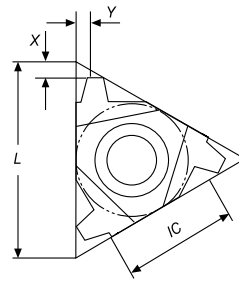
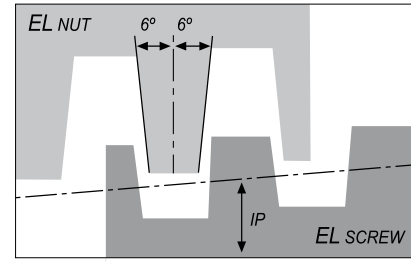

External

Geometry code (1) Código	Reference Referência Referencia	Pitch TPI	Taper IPF	Size	Dimensions Dimensões Dimensiones (mm)				Stock - Grade Code (2)	
					IC	L	X	Y	(68) PH6920	(D0) PH8920
1881329	22 ER 6 EL 1.5	6	1.5	5" - 7 5/8"	12.70	22	1.9	1.9	○	○
1881330	22 ER 5 EL 1.25	5	1.25	8 5/8" - 10 3/4"	12.70	22	2.4	2.3	○	○

Ⓢ Stock item | Produto de stock | Itens de stock

○ Available under request | Disponível sobre consulta | Disponible bajo consulta

Note: Order Code = (1) + (2)
See page E - 694 for more detail information

Internal

Geometry code (1) Código	Reference Referência Referencia	Pitch TPI	Taper IPF	Size	Dimensions Dimensões Dimensiones (mm)				Stock - Grade Code (2)	
					IC	L	X	Y	(68) PH6920	(D0) PH8920
1881339	22 IR 6 EL 1.5	6	1.5	5" - 7 5/8"	12.70	22	1.9	1.9	○	○
1881338	22 IR 5 EL 1.25	5	1.25	8 5/8" - 10 3/4"	12.70	22	2.4	2.3	○	○

Ⓢ Stock item | Produto de stock | Itens de stock

○ Available under request | Disponível sobre consulta | Disponible bajo consulta

Note: Order Code = (1) + (2)
See page E - 694 for more detail information

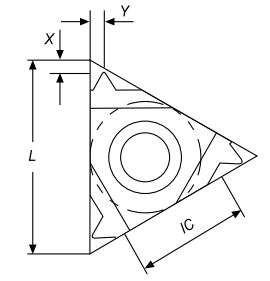
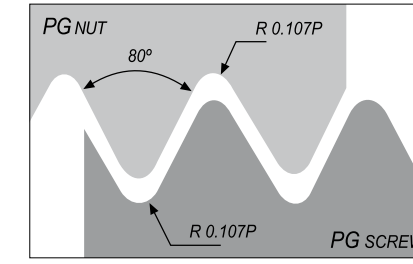
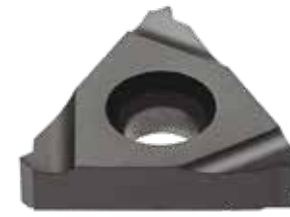

External

Geometry code (1) Código	Reference Referência Referencia	Pitch TPI	Size	Dimensions Dimensões Dimensiones (mm)				Stock - Grade Code (2)	
				IC	L	X	Y	(68) PH6920	(D0) PH8920
1882290	16 ER 20 PG	20	PG7	9.525	16	0.7	0.8	○	○
1882291	16 ER 18 PG	18	PG9, PG11, PG13.5, PG16	9.525	16	0.8	0.9	Ⓢ	○
1882292	16 ER 16 PG	16	PG21, PG29, PG36, PG42, PG48	9.525	16	0.8	1.0	○	○

Ⓢ Stock item | Produto de stock | Itens de stock

○ Available under request | Disponível sobre consulta | Disponible bajo consulta

Note: Order Code = (1) + (2)
See page E - 694 for more detail information

Internal

Geometry code (1) Código	Reference Referência Referencia	Pitch TPI	Size	Dimensions Dimensões Dimensiones (mm)				Stock - Grade Code (2)	
				IC	L	X	Y	(68) PH6920	(D0) PH8920
1883825	08 IR 20 PG	20	PG7	5.0	8	0.6	0.7	○	○
1882294	11 IR 18 PG	18	PG9, PG11, PG13.5, PG16	6.35	11	0.8	0.9	○	○
1882296	16 IR 18 PG	18	PG9, PG11, PG13.5, PG16	9.525	16	0.8	0.9	○	○
1882297	16 IR 16 PG	16	PG21, PG29, PG36, PG42, PG48	9.525	16	0.8	1.0	○	○

Ⓢ Stock item | Produto de stock | Itens de stock

○ Available under request | Disponível sobre consulta | Disponible bajo consulta

Note: Order Code = (1) + (2)
See page E - 694 for more detail information

TNMC (TANGENCIAL INSERTS)

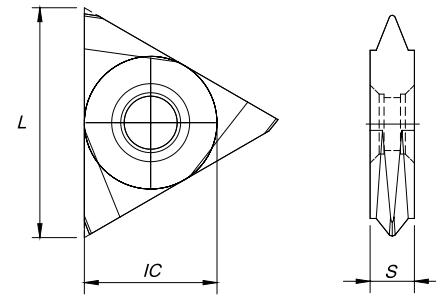

Geometry code (1) Código	Reference Referência Referencia	Dimensions Dimensões Dimensiones (mm)			Stock - Grade Code (2)	
		IC	L	S	(68) PH6920	(D0) PH8920
1110401	TPMC 1603 55	9,525	16,50	3,18	○	○
1110402	TPMC 1603 60	9,525	16,50	3,18	○	○
1110530	TPMC 2204 55	12,70	22,00	4,76	○	○
1110404	TPMC 2204 60	12,70	22,00	4,76	○	○

⊗ Stock item | Produto de stock | Itens de stock ○ Available under request | Disponível sobre consulta | Disponible bajo consulta

TPMC (TANGENCIAL INSERTS)

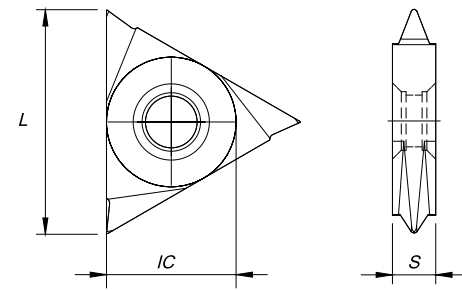

Geometry code (1) Código	Reference Referência Referencia	Dimensions Dimensões Dimensiones (mm)			Stock - Grade Code (2)	
		IC	L	S	(68) PH6920	(D0) PH8920
1110481	TNMC 1603 55	9,525	16,50	3,18	○	○
1110480	TNMC 1603 60	9,525	16,50	3,18	○	○
1110541	TNMC 2204 55	12,70	22,00	4,76	○	○
1110542	TNMC 2204 60	12,70	22,00	4,76	○	○

⊗ Stock item | Produto de stock | Itens de stock ○ Available under request | Disponível sobre consulta | Disponible bajo consulta

SPARE PARTS



Screws

Order Code Código	Reference Referência Referencia	Stock
290025000	P0200600	○
290044800	P0260700	⊗
290027200	P0351375	⊗
290027500	P0500990	○
290027800	P0501975	⊗
290055000	P0502200	○
290045100	P5000790	⊗
290044600	P5401390	⊗
290044900	P5401391	⊗
290045200	P8000990	⊗
290044700	P8001590	⊗
290045000	P8001591	⊗

⊗ Stock item | Produto de stock | Itens de stock

○ Available under request | Disponível sobre consulta | Disponible bajo consulta



Keys

Order Code Código	Reference Referência Referencia	Stock
290011400	XT06	⊗
290011700	XT08	⊗
290013100	XT10	⊗
290013200	XT20	⊗
290017400	XT25	⊗
290020300	SS20	○
290019800	SS25	○

⊗ Stock item | Produto de stock | Itens de stock

○ Available under request | Disponível sobre consulta | Disponible bajo consulta

Shims



Order Code Código	Reference Referência Referencia	Stock
212134400	EA16	○
212134500	EA16 1,5N	○
212134600	EA16 1N	○
212134700	EA16 1P	○
212134800	EA16 2N	○
212134900	EA16 2P	○
212135000	EA16 3N	○
212135100	EA16 3P	○
212135200	EA22	○
212135300	EA22 1,5N	○
212135400	EA22 1N	○
212135500	EA22 1P	○
212135600	EA22 2N	○
212135700	EA22 2P	○
212135800	EA22 3N	○
212135900	EA22 3P	○
212136000	IA16	○
212136100	IA16 1,5N	○
212136200	IA16 1N	○
212136300	IA16 1P	○
212136400	IA16 2N	○
212136500	IA16 2P	○
212136600	IA16 3N	○
212136700	IA16 3P	○
212136800	IA22	○
212136900	IA22 1,5N	○
212137000	IA22 1N	○
212137100	IA22 1P	○
212137200	IA22 2N	○
212137300	IA22 2P	○
212137400	IA22 3N	○
212137500	IA22 3P	○

⊗ Stock item | Produto de stock | Itens de stock

○ Available under request | Disponível sobre consulta | Disponible bajo consulta

S	T	C	N	R	25	25	M	16
1	2	3	4	5	6	7	8	9

1 - Clamping Method of Inserts

C	D	M	P	S

2 - Insert Shape

C	D	E	K
R	S	T	V
W	X		

4 - Clearance Angle of Inserts

B	C	N	P

5 - Hand of Tool

R	L	N

8 - Length of Holder (mm)

	D 60	P 70
	E 70	R 200
	F 80	S 250
	H 100	T 300
	K 125	U 350
	L 140	V 400
	M 150	X Special

3 - Holder Style

A	B	C
D	E	F
G	H	J
K	L	N
Q	R	S
T	V	X
Z		

6 - Height of Shank (mm)

	H
--	----------

7 - Width of Shank (mm)

	B
--	----------

9 - Length of Insert Cutting Edge (mm)

C,D,E,V	K	R	S
T	W	X	Z

STCN 90°

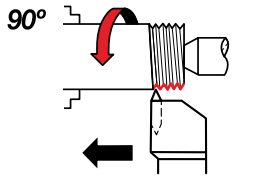
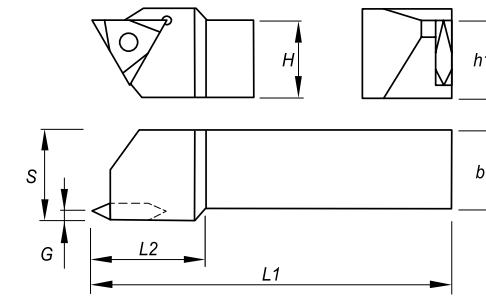

External Left

Order Code Código	Reference Referência Referencia	Insert Geometry	Dimensions Dimensões Dimensiones (mm)						Screw	Hex Key	Stock
			H=h1	b	S	L1	L2	G			
212129800	STCNL 1212 F16	TNMC/TPMC 16..	12	12	16	80	23	1.59	P0351375	SS20	☉
212129900	STCNL 1616 H16	TNMC/TPMC 16..	16	16	19	100	23	1.59	P0351375	SS20	☉
212029900	STCNL 2020 K16	TNMC/TPMC 16..	20	20	22	125	23	1.59	P0351375	SS20	☉
212130400	STCNL 2020 K22	TNMC/TPMC 22..	20	20	22	125	32	2.38	P0501975	SS25	☉
212030100	STCNL 2525 M16	TNMC/TPMC 16..	25	25	32	150	23	1.59	P0351375	SS20	☉
212030300	STCNL 2525 M22	TNMC/TPMC 22..	25	25	32	150	32	2.38	P0501975	SS25	☉
212130600	STCNL 3225 P22	TNMC/TPMC 22..	32	25	32	170	32	2.38	P0501975	SS25	☉
212130200	STCNL 3232 P16	TNMC/TPMC 16..	32	32	38	170	23	1.59	P0351375	SS20	☉
212130800	STCNL 3232 P22	TNMC/TPMC 22..	32	32	38	170	32	2.38	P0501975	SS25	☉

☉ Stock item | Produto de stock | Disponível sobre consulta
Itens de stock

○ Available under request | Disponível sobre consulta
Disponível bajo consulta

External Right

Order Code Código	Reference Referência Referencia	Insert Geometry	Dimensions Dimensões Dimensiones (mm)						Screw	Hex Key	Stock
			H=h1	b	S	L1	L2	G			
212103600	STCNR 1212 F16	TNMC/TPMC 16..	12	12	16	80	23	1.59	P0351375	SS20	☉
212103700	STCNR 1616 H16	TNMC/TPMC 16..	16	16	19	100	23	1.59	P0351375	SS20	☉
212029800	STCNR 2020 K16	TNMC/TPMC 16..	20	20	22	125	23	1.59	P0351375	SS20	☉
212130300	STCNR 2020 K22	TNMC/TPMC 22..	20	20	22	125	32	2.38	P0501975	SS25	☉
212030000	STCNR 2525 M16	TNMC/TPMC 16..	25	25	32	150	23	1.59	P0351375	SS20	☉
212030200	STCNR 2525 M22	TNMC/TPMC 22..	25	25	32	150	32	2.38	P0501975	SS25	☉
212130500	STCNR 3225 P22	TNMC/TPMC 22..	32	25	32	170	32	2.38	P0501975	SS25	☉
212130100	STCNR 3232 P16	TNMC/TPMC 16..	32	32	38	170	23	1.59	P0351375	SS20	☉
212130700	STCNR 3232 P22	TNMC/TPMC 22..	32	32	38	170	32	2.38	P0501975	SS25	☉

☉ Stock item | Produto de stock | Disponível sobre consulta
Itens de stock

○ Available under request | Disponível sobre consulta
Disponível bajo consulta

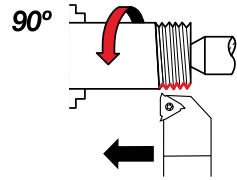
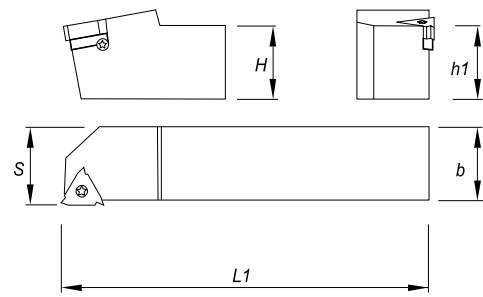

External Left

Order Code Código	Reference Referência Referencia	Insert Geometry	Dimensions Dimensões Dimensiones (mm)				Anvil	Anvil Screw	Insert Screw	Torx Key	Stock
			H=h1	b	s	L					
212244300	SXAN L 0808 H11	EL11	8	8	11	100	-	-	P0260700	XT08	○
212244400	SXAN L 1010 H11	EL11	10	10	11	100	-	-	P0260700	XT08	⊗
212384500	SXAN L 1212 K11	EL11	12	12	12	125	-	-	P0260700	XT08	○
212384600	SXAN L 1212 F16	EL16	12	12	16	80	IA16	P5000790	P5401390	XT10	○
212123400	SXAN L 1616 H16	EL16	16	16	16	100	IA16	P5000790	P5401390	XT10	○
212123500	SXAN L 2020 K16	EL16	20	20	20	125	IA16	P5000790	P5401390	XT10	⊗
212123800	SXAN L 2525 M16	EL16	25	25	25	150	IA16	P5000790	P5401390	XT10	⊗
212124400	SXAN L 3232 P16	EL16	32	32	32	170	IA16	P5000790	P5401390	XT10	○
212123900	SXAN L 2525 M22	EL22	25	25	25	150	IA22	P8000990	P8001590	XT20	⊗
212124200	SXAN L 3232 P22	EL22	32	32	32	170	IA22	P8000990	P8001590	XT20	⊗
212384700	SXAN L 4040 R22	EL22	40	40	40	200	IA22	P8000990	P8001590	XT20	○
212244500	SXAN L 2525 M27	EL27	25	25	32	150	IA27	P0500990	P0502200	XT25	○
212244600	SXAN L 3232 P27	EL27	32	32	32	170	IA27	P0500990	P0502200	XT25	○
212384800	SXAN L 4040 R27	EL27	40	40	40	200	IA27	P0500990	P0502200	XT25	○

⊗ Stock item | Produto de stock
Itens de stock

○ Available under request | Disponível sobre consulta
Disponível bajo consulta

External Right

Order Code Código	Reference Referência Referencia	Insert Geometry	Dimensions Dimensões Dimensiones (mm)				Anvil	Anvil Screw	Insert Screw	Torx Key	Stock
			H=h1	b	s	L					
212244700	SXAN R 0808 H11	ER11	8	8	10	100	-	-	P0260700	XT08	○
212244800	SXAN R 1010 H11	ER11	10	10	10	100	-	-	P0260700	XT08	⊗
212384900	SXAN R 1212 K11	ER11	12	12	12	125	-	-	P0260700	XT08	○
212383800	SXAN R 1212 F16	ER16	12	12	16	80	EA16	P5000790	P5401390	XT10	⊗
212053800	SXAN R 1616 H16	ER16	16	16	16	100	EA16	P5000790	P5401390	XT10	⊗
212053100	SXAN R 2020 K16	ER16	20	20	20	125	EA16	P5000790	P5401390	XT10	⊗
212053200	SXAN R 2525 M16	ER16	25	25	25	150	EA16	P5000790	P5401390	XT10	⊗
212124300	SXAN R 3232 P16	ER16	32	32	32	170	EA16	P5000790	P5401390	XT10	⊗
212053000	SXAN R 2525 M22	ER22	25	25	25	150	EA22	P8000990	P8001590	XT20	⊗
212124100	SXAN R 3232 P22	ER22	32	32	32	170	EA22	P8000990	P8001590	XT20	⊗
212385100	SXAN R 4040 R22	ER22	40	40	40	200	EA22	P8000990	P8001590	XT20	○
212244900	SXAN R 2525 M27	ER27	25	25	32	150	EA27	P0500990	P0502200	XT25	○
212245000	SXAN R 3232 P27	ER27	32	32	32	170	EA27	P0500990	P0502200	XT25	○
212385200	SXAN R 4040 R27	ER27	40	40	40	200	EA27	P0500990	P0502200	XT25	○

⊗ Stock item | Produto de stock
Itens de stock

○ Available under request | Disponível sobre consulta
Disponível bajo consulta

BORING BARS CODE KEY

Chave de codificação para suportes internos | Llave de codificación para roscado inferior



1 - Type of Bar		2 - Bar diameter (mm)	3 - Bar Length (mm)
A	Steel Shank with internal coolant.		
H	Anti-vibration shank (Heavy metal)		
J	Anti-vibration shank (Heavy metal) with internal coolant		
S	Steel shank		

4 - Method of Mounting Insert			
C	M	P	S

5 - Insert Shape			
C	D	E	K
S	T	V	W
X			

6 - Lead Angle of Boring Bar		
F	K	L
Q	U	U-BT
G		

7 - Relief Angle of Insert			
B	C	N	P

8 - Hand of Bar		
L	R	N

9 - Length of Cutting Edge (mm)					
C,D,E,V	K	S	T	W	X

STGN 90°

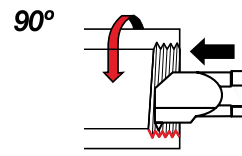
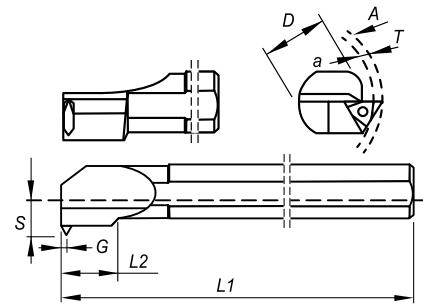

Internal Left

Order Code Código	Reference Referência Referencia	Insert	Dimensions Dimensões Dimensiones (mm)								Insert Screw	Hex Key	Stock
			D	L1	L2	S	A	a	T	G			
212121900	S32U STGN L 16	TNMC 1603..	32	350	19	21,0	50,4	45	2,7	1,59	P0351375	SS20	📦
212122200	S40V STGN L 16	TNMC 1603..	40	400	19	25,0	60,4	55	2,7	1,59	P0351375	SS20	📦
212122300	S32U STGN L 22	TNMC 2204..	32	350	28	21,0	50,4	45	4,1	2,38	P0501975	SS25	📦
212122600	S40V STGN L 22	TNMC 2204..	40	400	28	25,0	60,4	55	4,1	2,38	P0501975	SS25	📦
212122800	S50W STGN L 22	TNMC 2204..	50	450	28	36,5	78,2	70	4,1	2,38	P0501975	SS25	📦

📦 Stock item | Produto de stock
Itens de stock

○ Available under request | Disponível sobre consulta
Disponível bajo consulta

Internal Right

Order Code Código	Reference Referência Referencia	Insert	Dimensions Dimensões Dimensiones (mm)								Insert Screw	Hex Key	Stock
			D	L1	L2	S	A	a	T	G			
212053700	S32U STGN R 16	TNMC 1603..	32	350	19	21,0	50,4	45	2,7	1,59	P0351375	SS20	📦
212122100	S40V STGN R 16	TNMC 1603..	40	400	19	25,0	60,4	55	2,7	1,59	P0351375	SS20	📦
212122400	S32U STGN R 22	TNMC 2204..	32	350	28	21,0	50,4	45	4,1	2,38	P0501975	SS25	📦
212122500	S40V STGN R 22	TNMC 2204..	40	400	28	25,0	60,4	55	4,1	2,38	P0501975	SS25	📦
212122700	S50W STGN R 22	TNMC 2204..	50	450	28	36,5	78,2	70	4,1	2,38	P0501975	SS25	📦

📦 Stock item | Produto de stock
Itens de stock

○ Available under request | Disponível sobre consulta
Disponível bajo consulta

STGP 90°

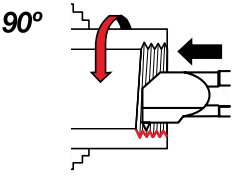
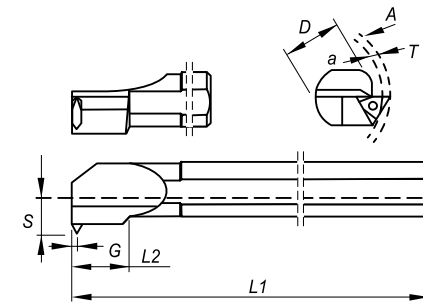

Internal Left

Order Code Código	Reference Referência Referencia	Insert	Dimensions Dimensões Dimensiones (mm)								Insert Screw	Hex Key	Stock
			D	L1	L2	S	A	a	T	G			
212030500	S25T STGP L 16	TPMC 1603..	25	300	19	17,5	50,4	45	2,7	1,59	P0351375	SS20	📦
212030700	S32U STGP L 16	TPMC 1603..	32	350	19	20,5	50,4	45	2,7	1,59	P0351375	SS20	📦
212030900	S40V STGP L 22	TPMC 2204..	40	400	28	25,0	78,2	70	4,1	2,38	P0501975	SS25	📦
212123000	S50W STGP L 22	TPMC 2204..	50	450	28	36,5	78,2	70	4,1	2,38	P0501975	SS25	📦

📦 Stock item | Produto de stock
Itens de stock

○ Available under request | Disponível sobre consulta
Disponível bajo consulta

Internal Right

Order Code Código	Reference Referência Referencia	Insert	Dimensions Dimensões Dimensiones (mm)								Insert Screw	Hex Key	Stock
			D	L1	L2	S	A	a	T	G			
212030400	S25T STGP R 16	TPMC 1603..	25	300	19	17,5	50,4	45	2,7	1,59	P0351375	SS20	📦
212030600	S32U STGP R 16	TPMC 1603..	32	350	19	20,5	50,4	45	2,7	1,59	P0351375	SS20	📦
212030800	S40V STGP R 22	TPMC 2204..	40	400	28	25,0	78,2	70	4,1	2,38	P0501975	SS25	📦
212122900	S50W STGP R 22	TPMC 2204..	50	450	28	36,5	78,2	70	4,1	2,38	P0501975	SS25	📦

📦 Stock item | Produto de stock
Itens de stock

○ Available under request | Disponível sobre consulta
Disponível bajo consulta

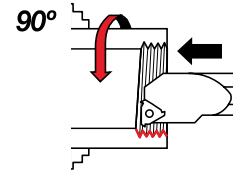
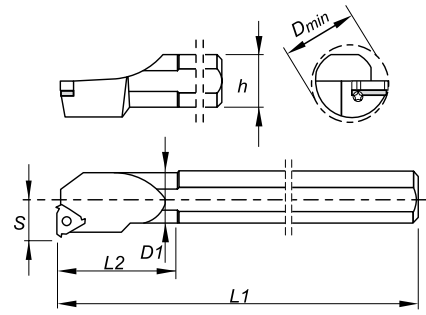

Internal Left

Order Code Código	Reference Referência Referencia	Insert Type	Dimensions Dimensões Dimensiones (mm)						Anvil	Anvil Screw	Insert Screw	Torx Key	Stock
			h	D1	Dmin	L1	L2	S					
212243500	S12H SXFN L 06	IL06	12	5,1	6	100	12	4,3	-	-	P0200400	XT06	⊗
212243600	S16K SXFN L 08	IL08	16	6,6	7,8	125	18	5,3	-	-	P0200600	XT06	⊗
212137600	S10H SXFN L 11	IL11	10	10	12	100	-	7,4	-	-	P0260700	XT08	⊗
212137800	S10K SXFN L 11	IL11	16	10	12	125	25	7,4	-	-	P0260700	XT08	○
212385300	S13L SXFN L 11	IL11	16	13	15	140	32	8,9	-	-	P0260700	XT08	○
212138000	S13M SXFN L 16	IL16	16	13	16	150	32	10,2	-	-	P5401391	XT10	○
212127400	S16P SXFN L 16	IL16	20	16	19	170	40	11,7	-	-	P5401391	XT10	⊗
212138200	S20P SXFN L 16	IL16	20	20	24	170	-	13,7	EA16	P5000790	P5401390	XT10	⊗
212125500	S25R SXFN L 16	IL16	25	25	29	200	-	16,2	EA16	P5000790	P5401390	XT10	⊗
212125700	S32S SXFN L 16	IL16	32	32	36	250	-	19,7	EA16	P5000790	P5401390	XT10	○
212125900	S40T SXFN L 16	IL16	40	40	44	300	-	23,7	EA16	P5000790	P5401390	XT10	○
212138300	S20P SXFN L 22	IL22	20	20	24	170	-	15,6	-	P8001591	XT20	⊗	
212126300	S25R SXFN L 22	IL22	25	25	29	200	-	18,1	EA22	P8000990	P8001590	XT20	⊗
212126500	S32S SXFN L 22	IL22	32	32	38	250	-	21,6	EA22	P8000990	P8001590	XT20	⊗
212126700	S40T SXFN L 22	IL22	40	40	46	300	-	25,6	EA22	P8000990	P8001590	XT20	○
212243700	S32S SXFN L 27	IL27	32	32	40	250	-	22,6	EA27	P0500990	P0502200	XT25	⊗
212243800	S40T SXFN L 27	IL27	40	40	48	300	-	26,6	EA27	P0500990	P0502200	XT25	○

Internal Right

Order Code Código	Reference Referência Referencia	Insert Type	Dimensions Dimensões Dimensiones (mm)						Anvil	Anvil Screw	Insert Screw	Torx Key	Stock
			h	D1	Dmin	L1	L2	S					
212243900	S12H SXFN R 06	IRO6	12	5	6,1	100	12	4,4	-	-	P0200400	XT06	⊗
212244000	S16K SXFN R 08	IRO8	16	6,5	8	125	17	5,4	-	-	P0200600	XT06	⊗
212137700	S10H SXFN R 11	IR11	10	10	12,5	100	-	7,3	-	-	P0260700	XT08	⊗
212137900	S10K SXFN R 11	IR11	16	10	12,5	125	25	7,3	-	-	P0260700	XT08	○
212385400	S10L SXFN R 11	IL11	16	13	15	140	32	8,9	-	-	P0260700	XT08	○
212138100	S13M SXFN R 16	IR16	16	13	16,5	150	32	10,4	-	-	P5401391	XT10	○
212127300	S16P SXFN R 16	IR16	20	16	19,5	170	40	11,6	-	-	P5401391	XT10	⊗
212138400	S20P SXFN R 16	IR16	20	20	23,5	170	-	13,6	IA16	P5000790	P5401390	XT10	⊗
212125400	S25R SXFN R 16	IR16	25	25	28,5	200	-	16,3	IA16	P5000790	P5401390	XT10	⊗
212125600	S32S SXFN R 16	IR16	32	32	35,5	250	-	19,6	IA16	P5000790	P5401390	XT10	○
212125800	S40T SXFN R 16	IR16	40	40	43,5	300	-	23,6	IA16	P5000790	P5401390	XT10	○
212138500	S20P SXFN R 22	IR22	20	20	25	170	-	15,5	-	P8001591	XT20	⊗	
212126200	S25R SXFN R 22	IR22	25	25	30	200	-	18,3	IA22	P8000990	P8001590	XT20	⊗
212126400	S32S SXFN R 22	IR22	32	32	37	250	-	21,7	IA22	P8000990	P8001590	XT20	⊗
212126600	S40T SXFN R 22	IR22	40	40	45	300	-	25,7	IA22	P8000990	P8001590	XT20	○
212244100	S32S SXFN R 27	IR27	32	32	39	250	-	22,8	IA27	P0500990	P0502200	XT25	⊗
212244200	S40T SXFN R 27	IR27	40	40	47	300	-	26,8	IA27	P0500990	P0502200	XT25	○

⊗ Stock item | Produto de stock
Itens de stock

○ Available under request | Disponível sobre consulta
Disponível bajo consulta

Note: All the toolholders are made with 1.5° helix angle. | Todos os ferros de torno são fornecidos com um ângulo de hélice de 1,5° | Todos los soportes se hacen con un ángulo de hélice de 1,5°.

ISO/ANSI			Coated Grades			
P	01	C8			- Wear resistance - Resistência ao desgaste - Resistencia al desgaste	
	10					
	20	C7	PH6920	PH8920		
	30	C6				
	40					
STEEL	50	C5			Toughness Tenacidade Tenacidad	
	M	10			- Wear resistance - Resistência ao desgaste - Resistencia al desgaste	
		20		PH6920		PH8920
		30				
		40				
STAINLESS STEEL	10				Toughness Tenacidade Tenacidad	
K	01	C4			- Wear resistance - Resistência ao desgaste - Resistencia al desgaste	
	10	C3				
	20	C2	PH6920	PH8920		
	30	C1				
	40					
CAST IRON	10				- Wear resistance - Resistência ao desgaste - Resistencia al desgaste	
N	01	C4			- Wear resistance - Resistência ao desgaste - Resistencia al desgaste	
	10	C3	PH6920			
	20	C2		PH0920		
	30	C1				
Z	10				- Wear resistance - Resistência ao desgaste - Resistencia al desgaste	
S	10				- Wear resistance - Resistência ao desgaste - Resistencia al desgaste	
	20		PH6920	PH8920		
	30					
HEAT RESISTENT / TITANIUM ALLOYS	10				- Wear resistance - Resistência ao desgaste - Resistencia al desgaste	
H	01	C4			- Wear resistance - Resistência ao desgaste - Resistencia al desgaste	
	10	C3				
	20	C2				
	30	C1				
HARDENED MATERIALS	10				- Wear resistance - Resistência ao desgaste - Resistencia al desgaste	

The position and the form of the grade symbols indicate the suitable field of application.

Centre of the field of application. Recommended field of application

GRADES DESCRIPTION

PH6920
 (P10-P35)
 (M10-M25)
 (K10-K30)
 (N05-N15)
 (S10-S30)

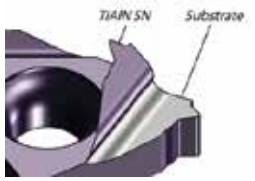

An advance PVD TiAlN coated grade over a tough wear-resistant submicron substrate for general purpose machining of steel, stainless steel, superalloys.

PH8920
 (P10-P35)
 (M10-M25)
 (K10-K30)
 (N05-N15)
 (S10-S30)

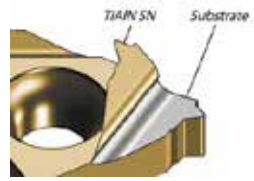

An advance PVD TiAlN+TiN coated grade over a tough wear-resistant submicron substrate for general purpose machining of steel, stainless steel, superalloys.

ORDER CODE INFORMATION

The order code is the combination between the geometry code of the insert plus the code of the grade.
 - E.g. 2120035 (16IR 14W) + 68 (PH6920) = 212003568
 Geometry Code + Grade Code = Order Code

RECOMMENDED GRADES AND CUTTING SPEEDS (m/min)

ISO	Material	Hardness HB	Coated	Coated
			PH6920	PH8920
			Cutting Speed m/min	
P	UNALLOYED STEEL	130	120-200	120-200
	LOW-ALLOYED STEEL	200	110-180	110-180
	HIGH-ALLOY STEEL	240	100-170	100-170
	STEEL CASTINGS	270	70-120	70-120
	HEAT TREATED STEEL	400	50-90	50-90
M	300 STAINLESS STEEL: (303,304,316)	200	70-140	70-140
	400 STAINLESS STEEL: (420,440)	240	80-120	80-120
	17-4 PH, 15-5 PH, 13-8MO PH	400	50-110	50-110
K	GREY CAST IRON	190	70-150	70-150
	NODULAR CAST IRON	180	100-140	100-140
	MALLEABLE CAST IRON	240	90-150	90-150
N	WROUGHT ALUMINIUM: (2024, 6061, 7075...)	80	100-400	100-400
	CAST ALUMINIUM:	90	150-400	150-400
	COPPER & COPPER-BRASS, BRONZE, COPPER SILICON	100	80-180	80-180
	NON METALIC: Rubber, polypropylene, Thermoplastics (PVC), Thermoplastics Plastics (FIBERGLASS), Polyamides		200-500	200-500
S	TITANIUM:			
	PURE TITANIUM: 99,0Ti		100-150	100-150
	ALPHA ALLOYS: Ti5Al2.5Sn		40-60	40-60
	BETA ALLOYS: Ti 13V11Cr3Al		30-50	30-50
	ALPHA - BETA ALLOYS: Ti 6Al4V		30-50	30-50
	COBALT BASE ALLOYS: STELLITE		20-40	20-40
	NIKEL BASE ALLOYS: INCONEL, HASTELLOY, WASSPALLOY, KOVAR		20-40	20-40
HIGH TEMPERATURE ALLOYS: IRON BASED: INCOLOY		30-60	30-60	
H	HARDENED STEEL	56 HRC	30-50	30-50
	HARDENED CAST IRON	50 HRC	25-35	25-35

THREAD TERMINOLOGY

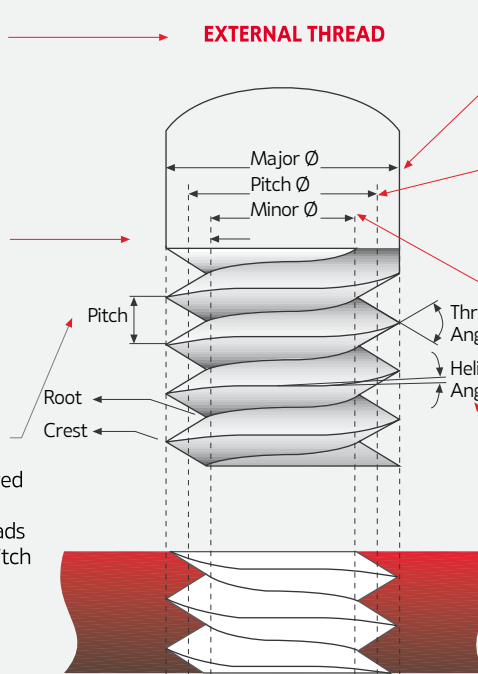

External Thread
 A thread on the external surface of a cylinder screw or cone.

Internal Thread
 A thread on the internal surface of a cylinder or cone.

Major Diameter
 The largest diameter of a screw thread.

Pitch Diameter
 On a straight thread, the diameter of an imaginary cylinder, the surface of which cuts the thread forms where the width of the thread and groove are equal.

Minor Diameter
 The smallest diameter of a screw thread.

Depth of Thread
 The distance between crest and root measured normal to the axis.

Pitch
 The distance between corresponding points on adjacent thread forms measured parallel to the axis. This distance can be defined in millimeters or by the *tpi* (threads per inch), which is the reciprocal of the pitch.

Thread Angle
Helix Angle

Helix Angle
 For a straight thread, where the lead of the thread and the pitch diameter circle circumference form a right angled triangle, the helix angle is the angle opposite the lead.

Straight Thread
 A thread formed on a cylinder.

Taper Thread
 A thread formed on a cone.

Nominal Diameter
 The diameter from which the diameter limits are derived by the application of deviation allowances and tolerances.

LEFT-HAND THREAD

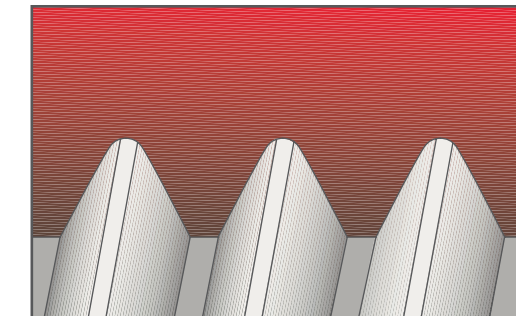

A thread which, when viewed axially, winds in a counter-clockwise and receding direction. All left-hand threads are designated LH.

RIGHT-HAND THREAD

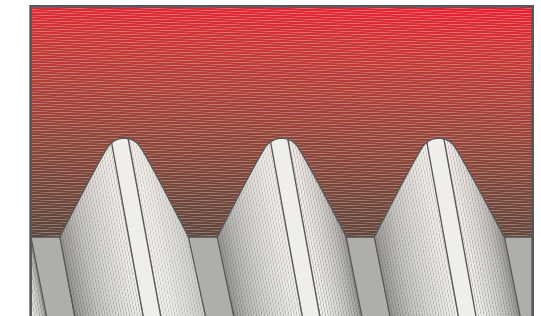

A thread which, when viewed axially, winds in a clockwise and receding direction. Threads are always right hand unless otherwise specified.

THE HELIX ANGLE

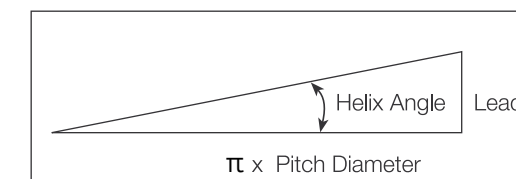

Lead
 The distance a threaded part moves axially, with respect to a fixed mating part, in one complete revolution.
 The lead is equal to the pitch multiplied by the number of thread starts.

PARTIAL PROFILE

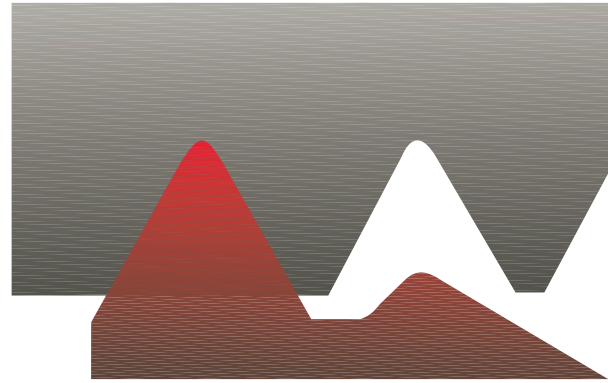

The V partial profile insert cuts without topping the outer diameter of the thread. The same insert can be used for a range of different thread pitches which have a common thread angle.

FULL PROFILE

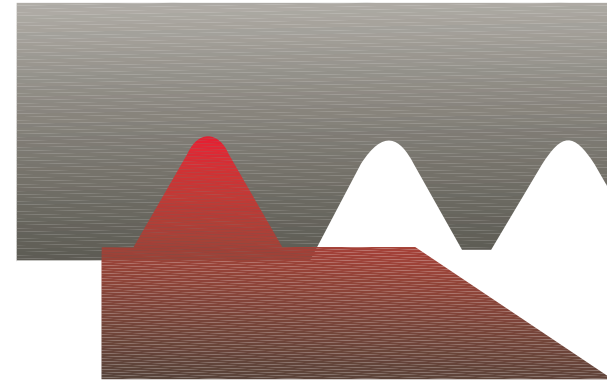

The full profile insert will form a complete thread profile including the crest. For every thread pitch and standard, a separate insert is required.

FULL PROFILE FOR FINE PITCHES

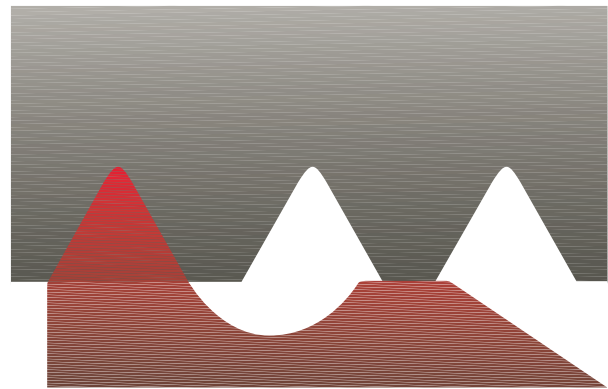

The full profile for Fine Pitches will form a complete thread. The topping of the outer diameter is generated by second tooth.

SEMI FULL

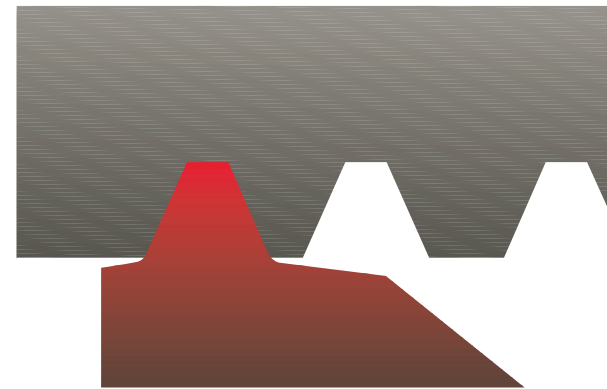

The Semi profile insert will form a complete thread including crest radius but without topping the outer diameter. Mainly used for trapezoidal profiles.

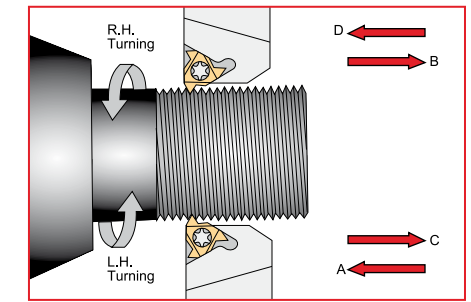
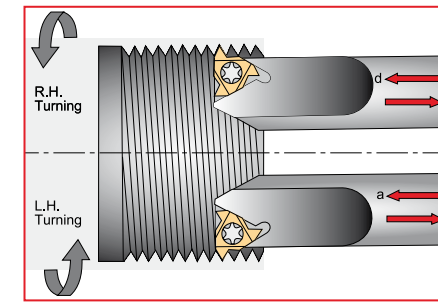

Thread	Inserts & Toolholders	Rotation	Feed Direction	Helix Method	Method
Right Hand external	EX RH	Anticlockwise	Towards chuck	Regular	A
	EX LH	Clockwise	From chuck	Reversed	B
Right Hand Internal	IN RH	Anticlockwise	Towards chuck	Regular	a
	IN LH	Clockwise	From chuck	Reversed	b
Left Hand External	EX LH	Clockwise	Towards chuck	Regular	D
	EX RH	Anticlockwise	From chuck	Reversed	C
Left Hand Internal	IN LH	Clockwise	Towards chuck	Regular	d
	IN RH	Anticlockwise	From chuck	Reversed	c

THREAD INFEEAD METHODS

RADIAL INFEEAD

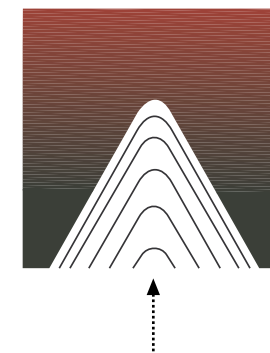

Radial infeed is the simplest and quickest method. The feed is perpendicular to the turning axis, and both flanks of the insert perform the cutting operation. Radial infeed is recommended in 3 cases:

- when the pitch is smaller than 16 tpi
- for material with short chips
- for work with hardened material

FLANK INFEEAD (modified)

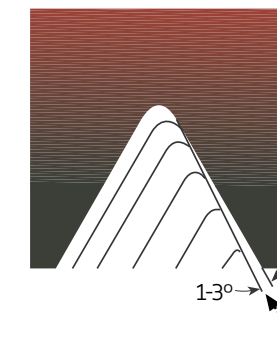

Flank infeed is recommended in the following cases:

- when the thread pitch is greater than 16 tpi., using the radial method, the effective cutting edge length is too large, resulting in chatter.
- for TRAPEZ and ACME. The radial method result in three cutting edges, making chip flow very difficult.

ALTERNATE FLANK INFEEAD

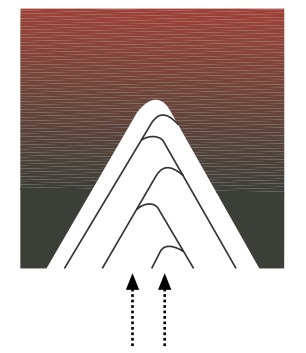

Use of the alternate flank method is recommended especially in large pitches and for materials with long chips. This method divides the load equally on both flanks, resulting in equal wear along the cutting edges. Alternate flank infeed requires more complicated programming, and is not available on all lathes.

Thread Inserts
Spare Parts
Thread Holders
Technical Data
THREADING

Thread Inserts
Spare Parts
Thread Holders
Technical Data
THREADING

CALCULATING THE HELIX ANGLE AND CHOOSING THE RIGHT ANVIL

FLANK CLEARANCE ANGLE a

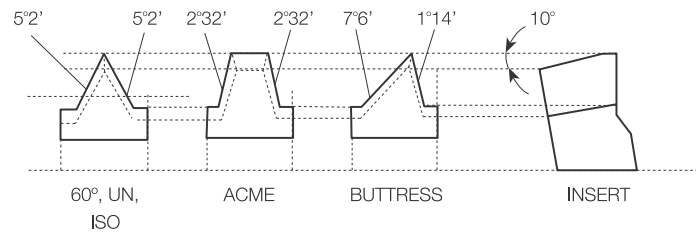

Palbit toolholders are designed to tilt the insert when seated in the toolholder (10° for external, 15° for internal tooling). This results in the differing flank clearance angles, based on the geometry of insert. To ensure that the side of the insert cutting edge will not rub on the workpiece, it is most important that the insert helix angle be correct - especially in profiles with small enclosed flank angles. This correction is provided by Palbit anvils.

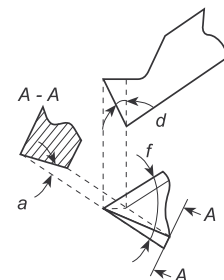

$$a = \arctan(\tan \varnothing / 2 \times \tan d)$$

Where: a - flank clearance angle
d - Tilt angle
Ø - Enclosed flank angle

CALCULATING THE HELIX ANGLE b

FORMULA

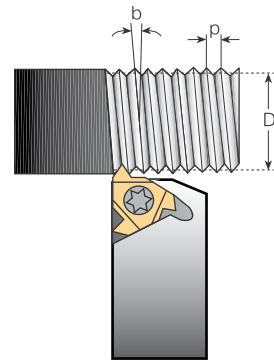

The helix angle is calculated by the following formula:

$$b = \arctan \frac{P \times N}{\pi \times D}$$

b - Helix angle (°)
P - Pitch (1/TPI)
N - No. of starts
D - Pitch diameter (mm)
Lead = P x N
TPI=Threads per inches

The helix angle can also be found using the diagram below

HELIX ANGLE DIAGRAM

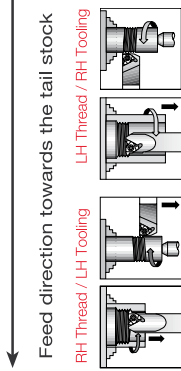
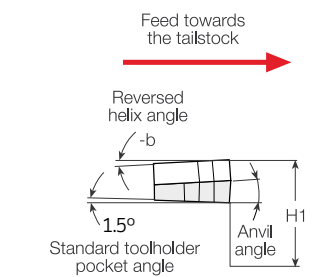
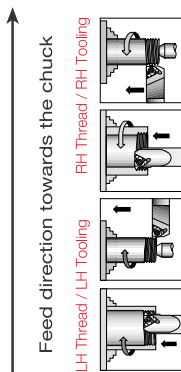
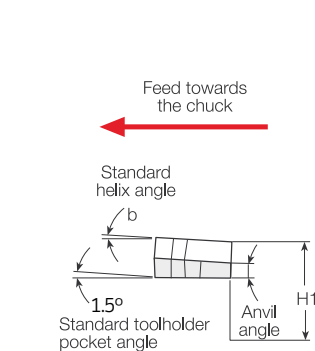

The dimension H1 (cutting edge height) remains constant with every insert / anvil combination

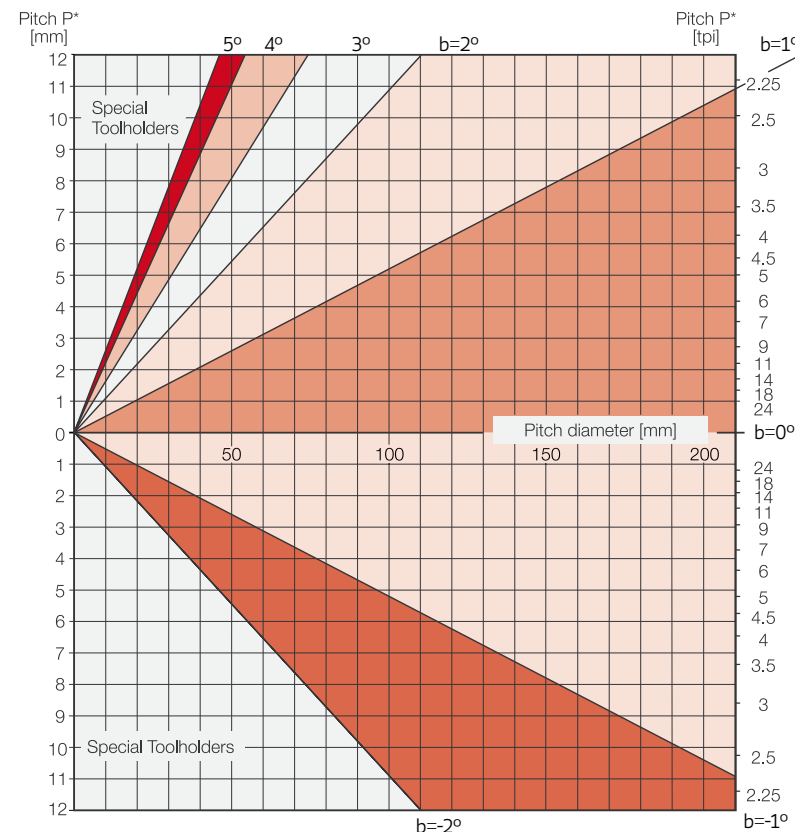

*For Multi-start threads, use the lead value instead of the pitch

NUMBER OF CUTTING PASSES

Pitch	MM	0.50	0.75	1.00	1.25	1.50	1.75	2.00	2.50	3.00	3.50	4.00	4.50	5.00	5.50	6.00	8.00
	TPI	48	32	24	20	16	14	12	10	8	7	6	5.5	5	4.5	4	3
No. of Passes		4-6	4-7	4-8	5-9	6-10	7-12	7-12	8-14	9-16	10-18	11-18	11-19	12-20	12-20	12-20	15-24

CALCULATION OF N (RPM)

$$N = \frac{1000 \times V_C}{\pi \times D}$$

$$V_C = \frac{N \times \pi \times D}{1000}$$

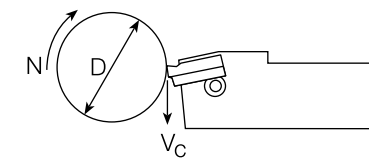

N - Revolution Per Minute [RPM]
V_C - Cutting Speed [m/min]
D - Workpiece Diameter [mm]

SHIMS

Insert Size		Holder Type	Resultant Helix Angle							
IC	L (mm)		4.5	3.5	2.5	1.5 standard	0.5	0	-0.5	-1.5
3/8"	16	ER/IL	EA16 3P	EA16 2P	EA16 1P	EA16	EA16 1N	EA16 1.5N	EA16 2N	EA16 3N
		EL/IR	IA16 3P	IA16 2P	IA16 1P	IA16	IA16 1N	IA16 1.5N	IA16 2N	IA16 3N
1/2"	22	ER/IL	EA22 3P	EA22 2P	EA22 1P	EA22	EA22 1N	EA22 1.5N	EA22 2N	EA22 3N
		EL/IR	IA22 3P	IA22 2P	IA22 1P	IA22	IA22 1N	IA22 1.5N	IA22 2N	IA22 3N
5/8"	27	ER/IL	EA27 3P	EA27 2P	EA27 1P	EA27	EA27 1N	EA27 1.5N	EA27 2N	EA27 3N
		EL/IR	IA27 3P	IA27 2P	IA27 1P	IA27	IA27 1N	IA27 1.5N	IA27 2N	IA27 3N

FLANK CLEARANCE ANGLE - γ

$$\gamma = \text{tg}^{-1}[\text{tg} \alpha \times \text{tg} \delta]$$

α = 10° for external

α = 15° for internal

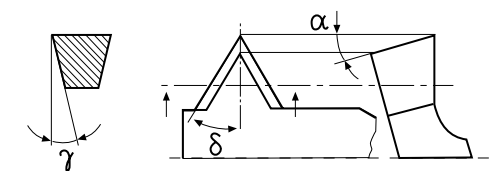

ISO METRIC EXTERNAL THREAD - RECOMMENDED NO. OF PASSES

No. of Passes	Pitch (MM)															
	6	5.5	5	4.5	4	3.5	3	2.5	2	1.75	1.5	1.25	1	0.75	0.5	0.35
1	0.45	0.43	0.42	0.39	0.34	0.34	0.27	0.26	0.24	0.23	0.23	0.20	0.19	0.17	0.11	0.10
2	0.37	0.36	0.37	0.33	0.30	0.31	0.23	0.22	0.23	0.21	0.21	0.18	0.16	0.15	0.09	0.08
3	0.33	0.31	0.31	0.29	0.25	0.24	0.20	0.20	0.19	0.16	0.18	0.14	0.13	0.11	0.08	0.06
4	0.28	0.27	0.28	0.25	0.21	0.20	0.18	0.17	0.17	0.14	0.16	0.12	0.10	0.06	0.06	
5	0.26	0.25	0.25	0.23	0.19	0.19	0.17	0.16	0.15	0.12	0.11	0.10	0.06			
6	0.24	0.23	0.23	0.20	0.18	0.17	0.16	0.14	0.12	0.10	0.06	0.06				
7	0.23	0.22	0.21	0.19	0.16	0.16	0.15	0.13	0.10	0.08						
8	0.22	0.20	0.20	0.18	0.15	0.15	0.13	0.12	0.06	0.06						
9	0.20	0.19	0.19	0.16	0.15	0.14	0.12	0.10								
10	0.19	0.18	0.18	0.15	0.14	0.12	0.11	0.06								
11	0.18	0.17	0.16	0.14	0.13	0.10	0.09									
12	0.17	0.16	0.14	0.12	0.12	0.06	0.06									
13	0.16	0.15	0.10	0.10	0.10											
14	0.14	0.12	0.06	0.06	0.06											
15	0.13	0.10														
16	0.10	0.06														
17	0.06															
18																
Total	3.71	3.40	3.10	2.79	2.48	2.18	1.87	1.56	1.26	1.10	0.95	0.80	0.64	0.49	0.34	0.24

UN EXTERNAL THREAD - RECOMMENDED NO. OF PASSES

No. of Passes	Pitch TPI																		
	4	4.5	5	6	7	8	9	10	11	12	13	14	16	18	20	24	28	32	48
1	0.44	0.43	0.42	0.37	0.33	0.29	0.29	0.26	0.25	0.25	0.24	0.23	0.22	0.21	0.20	0.20	0.18	0.18	0.13
2	0.38	0.35	0.37	0.32	0.28	0.22	0.24	0.22	0.22	0.23	0.22	0.20	0.20	0.19	0.16	0.17	0.15	0.16	0.09
3	0.33	0.30	0.32	0.27	0.23	0.20	0.23	0.20	0.19	0.20	0.18	0.18	0.18	0.17	0.15	0.14	0.11	0.12	0.07
4	0.29	0.28	0.27	0.25	0.22	0.18	0.22	0.17	0.17	0.18	0.16	0.14	0.14	0.16	0.13	0.11	0.09	0.06	0.06
5	0.27	0.26	0.26	0.24	0.21	0.17	0.18	0.16	0.16	0.16	0.14	0.12	0.11	0.11	0.11	0.06	0.06		
6	0.26	0.23	0.24	0.18	0.19	0.16	0.16	0.15	0.15	0.14	0.13	0.11	0.09	0.06	0.06				
7	0.24	0.22	0.22	0.17	0.18	0.16	0.15	0.14	0.13	0.11	0.10	0.10	0.06						
8	0.23	0.21	0.20	0.16	0.15	0.15	0.12	0.12	0.12	0.06	0.06	0.06							
9	0.21	0.20	0.19	0.15	0.14	0.14	0.11	0.11	0.06										
10	0.20	0.19	0.18	0.13	0.14	0.14	0.06	0.06											
11	0.19	0.18	0.17	0.12	0.12	0.11													
12	0.18	0.17	0.14	0.10	0.06	0.06													
13	0.18	0.15	0.11	0.11															
14	0.17	0.14	0.06	0.06															
15	0.16	0.12																	
16	0.13	0.06																	
17	0.06																		
Total	3.92	3.49	3.15	2.63	2.25	1.98	1.76	1.59	1.45	1.33	1.23	1.14	1.00	0.90	0.81	0.68	0.59	0.52	0.35

ISO METRIC INTERNAL THREAD - RECOMMENDED NO. OF PASSES

No. of Passes	Pitch (MM)															
	6	5.5	5	4.5	4	3.5	3	2.5	2	1.75	1.5	1.25	1	0.75	0.5	0.35
1	0.44	0.43	0.42	0.36	0.32	0.32	0.25	0.25	0.23	0.22	0.22	0.19	0.18	0.16	0.10	0.09
2	0.36	0.34	0.37	0.32	0.27	0.29	0.22	0.21	0.21	0.20	0.20	0.16	0.15	0.14	0.09	0.08
3	0.32	0.29	0.28	0.28	0.22	0.23	0.19	0.19	0.18	0.15	0.17	0.13	0.12	0.10	0.07	0.06
4	0.27	0.24	0.26	0.25	0.20	0.19	0.17	0.16	0.16	0.13	0.15	0.11	0.10	0.06	0.06	
5	0.25	0.23	0.24	0.22	0.19	0.18	0.16	0.15	0.14	0.11	0.10	0.10	0.06			
6	0.23	0.22	0.21	0.19	0.18	0.16	0.16	0.13	0.11	0.09	0.06	0.06				
7	0.22	0.21	0.20	0.18	0.16	0.15	0.14	0.12	0.09	0.08						
8	0.21	0.20	0.19	0.17	0.15	0.14	0.12	0.11	0.06	0.06						
9	0.19	0.18	0.18	0.15	0.14	0.13	0.11	0.09								
10	0.17	0.16	0.16	0.14	0.14	0.11	0.10	0.06								
11	0.16	0.16	0.14	0.12	0.12	0.09	0.08									
12	0.15	0.15	0.12	0.10	0.10	0.06	0.06									
13	0.14	0.14	0.09	0.09	0.09											
14	0.13	0.11	0.06	0.06	0.06											
15	0.11	0.09														
16	0.09	0.06														
17	0.06															
18																
Total	3.50	3.21	2.92	2.63	2.34	2.05	1.76	1.47	1.18	1.04	0.90	0.75	0.61	0.46	0.32	0.23

UN INTERNAL THREAD - RECOMMENDED NO. OF PASSES

No. of Passes	Pitch TPI																		
	4	4.5	5	6	7	8	9	10	11	12	13	14	16	18	20	24	28	32	48
1	0.43	0.43	0.42	0.34	0.31	0.29	0.29	0.25	0.24	0.24	0.23	0.22	0.21	0.20	0.19	0.19	0.17	0.17	0.12
2	0.34	0.35	0.37	0.28	0.27	0.22	0.23	0.21	0.20	0.21	0.21	0.20	0.19	0.18	0.16	0.16	0.14	0.15	0.09
3	0.32	0.29	0.28	0.26	0.22	0.19	0.20	0.19	0.18	0.19	0.17	0.17	0.17	0.16	0.14	0.13	0.10	0.11	0.07
4	0.28	0.24	0.26	0.22	0.20	0.17	0.20	0.16	0.16	0.17	0.15	0.13	0.13	0.15	0.11	0.10	0.08	0.06	0.06
5	0.26	0.23	0.24	0.21	0.19	0.16	0.16	0.15	0.15	0.15	0.13	0.11	0.10	0.09	0.10	0.06	0.06		
6	0.25	0.22	0.21	0.18	0.18	0.16	0.15	0.13	0.14	0.13	0.12	0.10	0.09	0.06	0.06				
7	0.23	0.21	0.20	0.17	0.16	0.14	0.14	0.12	0.12	0.10	0.09	0.09	0.06						
8	0.21	0.20	0.19	0.16	0.15	0.14	0.13	0.12	0.10	0.06	0.06	0.06							
9	0.20	0.19	0.18	0.15	0.14	0.13	0.11	0.11	0.06										
10	0.19	0.18	0.16	0.13	0.14	0.12	0.06	0.06											
11	0.18	0.17	0.16	0.12	0.10	0.08													
12	0.17	0.16	0.13	0.10	0.06	0.06													
13	0.16	0.14	0.10	0.09															
14	0.16	0.12	0.06	0.06															
15	0.14	0.10																	
16	0.12	0.06																	
17	0.06																		
Total	3.70	3.29	2.96	2.47	2.12	1.86	1.67	1.50	1.35	1.25	1.16	1.08	0.95	0.84	0.76	0.64	0.55	0.49	0.34

W. EXTERNAL THREAD - RECOMMENDED NO. OF PASSES

No. of Passes	Pitch TPI																		
	4	4.5	5	6	7	8	9	10	11	12	14	16	18	19	20	24	28	32	48
1	0.45	0.44	0.43	0.38	0.34	0.30	0.28	0.27	0.26	0.26	0.24	0.22	0.24	0.22	0.21	0.20	0.18	0.19	0.16
2	0.40	0.36	0.38	0.33	0.29	0.24	0.25	0.23	0.23	0.23	0.21	0.18	0.21	0.19	0.19	0.18	0.15	0.16	0.14
3	0.35	0.31	0.33	0.28	0.24	0.21	0.22	0.21	0.20	0.21	0.17	0.15	0.16	0.17	0.15	0.16	0.12	0.13	0.06
4	0.31	0.29	0.28	0.27	0.23	0.19	0.21	0.18	0.18	0.19	0.15	0.13	0.15	0.14	0.13	0.11	0.10	0.06	
5	0.28	0.27	0.27	0.25	0.22	0.18	0.20	0.17	0.17	0.17	0.14	0.12	0.11	0.11	0.10	0.06	0.06		
6	0.27	0.24	0.25	0.19	0.20	0.17	0.17	0.16	0.16	0.15	0.12	0.10	0.06	0.06	0.06				
7	0.25	0.23	0.23	0.18	0.19	0.17	0.17	0.14	0.13	0.12	0.10	0.09							
8	0.24	0.22	0.21	0.17	0.16	0.16	0.15	0.13	0.12	0.06	0.06	0.06							
9	0.22	0.21	0.20	0.16	0.15	0.14	0.13	0.11	0.06										
10	0.21	0.20	0.19	0.14	0.15	0.13	0.06	0.06											
11	0.20	0.19	0.18	0.12	0.12	0.11													
12	0.19	0.18	0.15	0.10	0.06	0.06													
13	0.18	0.16	0.12	0.11															
14	0.18	0.15	0.06	0.06															
15	0.17	0.13																	
16	0.13	0.06																	
17	0.06																		
Total	4.09	3.64	3.28	2.74	2.35	2.06	1.84	1.66	1.51	1.39	1.19	1.05	0.93	0.89	0.84	0.71	0.61	0.54	0.36

NPT EXTERNAL & INTERNAL RECOMMENDED NO. OF PASSES

No. of Passes	Pitch TPI				
	4	11.5	14	18	27
1	0.32	0.23	0.22	0.18	0.14
2	0.25	0.19	0.18	0.15	0.11
3	0.21	0.17	0.15	0.13	0.11
4	0.17	0.16	0.14	0.13	0.10
5	0.16	0.15	0.13	0.12	0.09
6	0.16	0.13	0.12	0.11	0.08
7	0.15	0.12	0.10	0.09	0.06
8	0.15	0.10	0.10	0.08	
9	0.14	0.10	0.09	0.06	
10	0.13	0.10	0.08		
11	0.13	0.09	0.06		
12	0.12	0.08			
13	0.12	0.06			
14	0.10				
15	0.08				
16	0.06				
Total	2.45	1.68	1.37	1.05	0.69

NPTF EXTERNAL & INTERNAL RECOMMENDED NO. OF PASSES

No. of Passes	Pitch TPI				
	8	11.5	14	18	27
1	0.31	0.22	0.21	0.17	0.14
2	0.24	0.17	0.17	0.14	0.10
3	0.20	0.16	0.14	0.13	0.09
4	0.16	0.16	0.14	0.12	0.09
5	0.16	0.14	0.14	0.11	0.08
6	0.15	0.13	0.12	0.10	0.08
7	0.15	0.12	0.10	0.09	0.06
8	0.14	0.11	0.10	0.08	
9	0.14	0.10	0.09	0.06	
10	0.13	0.10	0.08		
11	0.13	0.09	0.06		
12	0.12	0.08			
13	0.12	0.06			
14	0.10				
15	0.08				
16	0.06				
Total	2.39	1.64	1.35	1.00	0.64

W. INTERNAL THREAD - RECOMMENDED NO. OF PASSES

No. of Passes	Pitch TPI																		
	4	4.5	5	6	7	8	9	10	11	12	14	16	18	19	20	24	28	32	48
1	0.45	0.44	0.43	0.38	0.34	0.30	0.28	0.27	0.26	0.26	0.24	0.22	0.24	0.22	0.21	0.20	0.18	0.19	0.16
2	0.40	0.36	0.38	0.33	0.29	0.24	0.25	0.23	0.23	0.23	0.21	0.18	0.21	0.19	0.19	0.18	0.15	0.16	0.14
3	0.35	0.31	0.33	0.28	0.24	0.21	0.22	0.21	0.20	0.21	0.17	0.15	0.16	0.17	0.15	0.16	0.12	0.13	0.06
4	0.31	0.29	0.28	0.27	0.23	0.19	0.21	0.18	0.18	0.19	0.15	0.13	0.15	0.14	0.13	0.11	0.10	0.06	
5	0.28	0.27	0.27	0.25	0.22	0.18	0.20	0.17	0.17	0.17	0.14	0.12	0.11	0.11	0.10	0.06	0.06		
6	0.27	0.24	0.25	0.19	0.20	0.17	0.17	0.16	0.16	0.15	0.12	0.10	0.06	0.06	0.06				
7	0.25	0.23	0.23	0.18	0.19	0.17	0.17	0.14	0.13	0.12	0.10	0.09							
8	0.24	0.22	0.21	0.17	0.16	0.16	0.15	0.13	0.12	0.06	0.06	0.06							
9	0.22	0.21	0.20	0.16	0.15	0.14	0.13	0.11	0.06										
10	0.21	0.20	0.19	0.14	0.15	0.13	0.06	0.06											
11	0.20	0.19	0.18	0.12	0.12	0.11													
12	0.19	0.18	0.15	0.10	0.06	0.06													
13	0.18	0.16	0.12	0.11															
14	0.18	0.15	0.06	0.06															
15	0.17	0.13																	
16	0.13	0.06																	
17	0.06																		
Total	4.09	3.64	3.28	2.74	2.35	2.06	1.84	1.66	1.51	1.39	1.19	1.05	0.93	0.89	0.84	0.71	0.61	0.54	0.36

TR EXTERNAL & INTERNAL - RECOMMENDED NO. OF PASSES

No. of Passes	Pitch (MM)						
	7.0	6.0	5.0	4.0	3.0	2.0	1.5
1	0.38	0.36	0.34	0.32	0.31	0.30	0.24
2	0.34	0.32	0.30	0.28	0.26	0.26	0.22
3	0.28	0.28	0.25	0.23	0.23	0.22	0.17
4	0.26	0.25	0.23	0.20	0.19	0.18	0.14
5	0.25	0.24	0.22	0.19	0.19	0.16	0.12
6	0.23	0.23	0.21	0.18	0.18	0.12	0.06
7	0.22	0.22	0.19	0.17	0.15	0.06	
8	0.21	0.20	0.18	0.16	0.12		
9	0.20	0.19	0.17	0.15	0.11		
10	0.19	0.17	0.16	0.14	0.06		
11	0.19	0.16	0.14	0.12			
12	0.18	0.15	0.13	0.10			
13	0.18	0.13	0.12	0.06			
14	0.16	0.13	0.10				
15	0.16	0.12	0.06				
16	0.15	0.12					
17	0.15	0.11					
18	0.14	0.11					
19	0.12	0.06					
20	0.06						
Total	4.05	3.55	2.80	2.30	1.80	1.30	0.95

ACME EXTERNAL & INTERNAL - RECOMMENDED NO. OF PASSES

No. of Passes	Pitch TPI							
	4	5	6	8	10	12	14	16
1	0.36	0.34	0.31	0.27	0.26	0.26	0.25	0.24
2	0.32	0.30	0.29	0.23	0.23	0.22	0.21	0.22
3	0.28	0.25	0.25	0.19	0.20	0.18	0.18	0.18
4	0.25	0.23	0.21	0.18	0.19	0.16	0.15	0.15
5	0.24	0.22	0.18	0.17	0.16	0.14	0.13	0.12
6	0.23	0.21	0.17	0.16	0.14	0.12	0.10	0.06
7	0.22	0.19	0.16	0.15	0.12	0.10	0.06	
8	0.20	0.19	0.15	0.14	0.11	0.06		
9	0.19	0.18	0.15	0.12	0.10			
10	0.17	0.17	0.14	0.12	0.06			
11	0.15	0.15	0.13	0.10				
12	0.14	0.13	0.12	0.06				
13	0.13	0.12	0.10					
14	0.12	0.10	0.06					
15	0.11	0.06						
16	0.11							
17	0.10							
18	0.10							
19	0.06							
Total	3.48	2.84	2.42	1.89	1.57	1.24	1.08	0.97

STUB ACME EXTERNAL & INTERNAL - RECOMMENDED NO. OF PASSES

No. of Passes	Pitch TPI							
	4	5	6	8	10	12	14	16
1	0.31	0.30	0.27	0.23	0.23	0.22	0.21	0.18
2	0.26	0.26	0.23	0.19	0.17	0.17	0.18	0.16
3	0.21	0.21	0.20	0.16	0.14	0.14	0.15	0.13
4	0.19	0.18	0.16	0.15	0.13	0.12	0.12	0.12
5	0.17	0.16	0.15	0.13	0.12	0.10	0.06	0.06
6	0.17	0.15	0.14	0.12	0.11	0.06		
7	0.16	0.15	0.13	0.11	0.10			
8	0.15	0.13	0.12	0.10	0.06			
9	0.15	0.12	0.10	0.06				
10	0.14	0.10	0.06					
11	0.13	0.06						
12	0.11							
13	0.06							
Total	2.21	1.82	1.56	1.25	1.06	0.81	0.72	0.65

UNJ EXTERNAL THREAD - RECOMMENDED NO. OF PASSES

No. of Passes	Pitch TPI												
	8	9	10	11	12	13	14	16	18	20	24	28	32
1	0.29	0.29	0.26	0.25	0.25	0.24	0.23	0.22	0.21	0.20	0.20	0.18	0.18
2	0.22	0.24	0.22	0.22	0.23	0.22	0.20	0.20	0.19	0.16	0.17	0.14	0.15
3	0.20	0.22	0.19	0.19	0.19	0.18	0.17	0.17	0.16	0.14	0.13	0.10	0.11
4	0.18	0.20	0.17	0.16	0.17	0.15	0.14	0.13	0.15	0.12	0.10	0.09	0.06
5	0.16	0.17	0.15	0.15	0.15	0.13	0.11	0.10	0.10	0.10	0.06	0.06	
6	0.16	0.16	0.14	0.14	0.13	0.12	0.10	0.09	0.06				
7	0.15	0.14	0.13	0.12	0.10	0.09	0.09	0.06					
8	0.14	0.12	0.11	0.11	0.06	0.06	0.06						
9	0.13	0.10	0.10	0.06									
10	0.12	0.06	0.06										
11	0.10												
12	0.06												
Total	1.91	1.70	1.53	1.40	1.28	1.19	1.10	0.97	0.87	0.78	0.66	0.57	0.50

UNJ INTERNAL THREAD - RECOMMENDED NO. OF PASSES

No. of Passes	Pitch TPI												
	8	9	10	11	12	13	14	16	18	20	24	28	32
1	0.29	0.29	0.26	0.25	0.25	0.24	0.23	0.22	0.21	0.20	0.20	0.18	0.18
2	0.22	0.24	0.22	0.22	0.23	0.22	0.20	0.20	0.19	0.16	0.17	0.14	0.15
3	0.20	0.22	0.19	0.19	0.19	0.18	0.17	0.17	0.16	0.14	0.13	0.10	0.11
4	0.18	0.20	0.17	0.16	0.17	0.15	0.14	0.13	0.15	0.12	0.10	0.09	0.06
5	0.16	0.17	0.15	0.15	0.15	0.13	0.11	0.10	0.10	0.10	0.06	0.06	
6	0.16	0.16	0.14	0.14	0.13	0.12	0.10	0.09	0.06	0.06			
7	0.15	0.14	0.13	0.12	0.10	0.09	0.09	0.06					
8	0.14	0.12	0.11	0.11	0.06	0.06	0.06						
9	0.13	0.10	0.10	0.06									
10	0.12	0.06	0.06										
11	0.10												
12	0.06												
Total	1.91	1.70	1.53	1.40	1.28	1.19	1.10	0.97	0.87	0.78	0.66	0.57	0.50

TECHNICAL DATA

MJ INTERNAL THREAD RECOMMENDED NO. OF PASSES

No. of Passes	Pitch (MM)					
	1.0	1.25	1.5	2.0	2.5	3.0
1	0.16	0.17	0.22	0.23	0.24	0.24
2	0.13	0.14	0.19	0.21	0.21	0.20
3	0.11	0.12	0.14	0.18	0.18	0.18
4	0.09	0.10	0.11	0.16	0.16	0.17
5	0.06	0.09	0.09	0.14	0.14	0.16
6		0.06	0.06	0.10	0.13	0.15
7				0.06	0.12	0.13
8					0.10	0.12
9					0.06	0.10
10						0.09
11						0.06
12						
Total	0.55	0.68	0.81	1.08	1.34	1.60

MJ EXTERNAL THREAD RECOMMENDED NO. OF PASSES

No. of Passes	Pitch (MM)					
	1.0	1.25	1.5	2.0	2.5	3.0
1	0.18	0.18	0.22	0.23	0.25	0.26
2	0.15	0.16	0.20	0.22	0.21	0.22
3	0.13	0.14	0.18	0.18	0.19	0.19
4	0.10	0.12	0.15	0.16	0.16	0.17
5	0.06	0.10	0.11	0.14	0.15	0.16
6		0.06	0.06	0.12	0.14	0.15
7				0.10	0.13	0.14
8				0.06	0.12	0.13
9					0.10	0.12
10					0.06	0.11
11						0.09
12						0.06
Total	0.62	0.76	0.92	1.21	1.51	1.80

PG INTERNAL & EXTERNAL - RECOMMENDED NO. OF PASSES

No. of Passes	Pitch TPI		
	20	18	16
1	0.17	0.18	0.19
2	0.15	0.14	0.16
3	0.14	0.12	0.13
4	0.10	0.10	0.11
5	0.06	0.09	0.10
6		0.06	0.09
7			0.06
Total	0.62	0.69	0.78

AMERICAN BUTTRESS EXTERNAL & INTERNAL RECOMMENDED NO. OF PASSES

No. of Passes	Pitch TPI					
	6	8	10	12	16	20
1	0.28	0.25	0.22	0.21	0.20	0.18
2	0.24	0.22	0.20	0.19	0.18	0.16
3	0.21	0.19	0.19	0.18	0.17	0.14
4	0.20	0.19	0.17	0.16	0.14	0.13
5	0.20	0.17	0.16	0.15	0.13	0.12
6	0.19	0.16	0.15	0.14	0.12	0.10
7	0.19	0.16	0.13	0.13	0.10	0.06
8	0.18	0.15	0.12	0.12	0.06	
9	0.17	0.14	0.12	0.11		
10	0.16	0.13	0.11	0.06		
11	0.15	0.12	0.10			
12	0.14	0.11	0.06			
13	0.14	0.10				
14	0.13	0.06				
15	0.12					
16	0.10					
17	0.06					
Total	2.86	2.15	1.73	1.45	1.10	0.89

RD (DIN 20400) EXTERNAL & INTERNAL THREAD RECOMMENDED NO. OF PASSES

No. of Passes	Pitch (MM)			
	6.0	5.0	4.0	3.0
1	0.35	0.32	0.25	0.24
2	0.33	0.28	0.24	0.23
3	0.32	0.27	0.23	0.21
4	0.31	0.26	0.22	0.20
5	0.30	0.25	0.21	0.19
6	0.29	0.24	0.20	0.18
7	0.26	0.22	0.19	0.14
8	0.23	0.20	0.18	0.11
9	0.22	0.19	0.16	0.10
10	0.19	0.16	0.14	0.09
11	0.17	0.15	0.12	0.06
12	0.15	0.13	0.10	
13	0.12	0.12	0.06	
14	0.10	0.06		
15	0.06			
Total	3.40	2.85	2.30	1.75

RD (DIN 405) EXTERNAL & INTERNAL THREAD RECOMMENDED NO. OF PASSES

No. of Passes	Pitch TPI			
	4	6	8	10
1	0.35	0.25	0.24	0.23
2	0.32	0.24	0.22	0.21
3	0.31	0.22	0.20	0.19
4	0.30	0.21	0.19	0.18
5	0.29	0.20	0.18	0.16
6	0.28	0.19	0.16	0.14
7	0.25	0.18	0.14	0.11
8	0.22	0.16	0.11	0.09
9	0.21	0.15	0.10	0.06
10	0.18	0.13	0.09	
11	0.16	0.12	0.06	
12	0.13	0.11		
13	0.12	0.06		
14	0.10			
15	0.06			
Total	3.28	2.22	1.69	1.37

SAGENGWINDE (DIN 513) EXTERNAL - RECOMMENDED NO. OF PASSES

No. of Passes	Pitch (MM)		
	4.0	3.0	2.0
1	0.32	0.30	0.29
2	0.30	0.28	0.26
3	0.27	0.26	0.24
4	0.25	0.24	0.19
5	0.23	0.22	0.18
6	0.21	0.21	0.17
7	0.20	0.20	0.15
8	0.19	0.18	0.14
9	0.18	0.17	0.11
10	0.17	0.15	0.06
11	0.16	0.14	
12	0.15	0.13	
13	0.15	0.11	
14	0.15	0.06	
15	0.14		
16	0.14		
17	0.13		
18	0.12		
19	0.06		
Total	3.52	2.65	1.79

SAGENGWINDE (DIN 513) INTERNAL - RECOMMENDED NO. OF PASSES

No. of Passes	Pitch (MM)		
	4.0	3.0	2.0
1	0.32	0.31	0.29
2	0.30	0.29	0.27
3	0.27	0.27	0.25
4	0.24	0.24	0.21
5	0.23	0.23	0.18
6	0.21	0.22	0.16
7	0.20	0.20	0.12
8	0.19	0.19	0.06
9	0.18	0.16	
10	0.17	0.13	
11	0.16	0.06	
12	0.15		
13	0.14		
14	0.13		
15	0.10		
16	0.06		
Total	3.05	2.30	1.54

API EXTERNAL & INTERNAL - RECOMMENDED NO. OF PASSES

No. of Passes	VO.038R 4 TPI		VO.050 4 TPI		VO.040 5 TPI	Buttress casing 5 TPI	
	2 IPF	3 IPF	2 IPF	3 IPF	3 IPF	0.75 IPF	1.0 IPF
1	0.45	0.45	0.44	0.44	0.41	0.24	0.24
2	0.38	0.38	0.39	0.39	0.36	0.22	0.22
3	0.33	0.33	0.34	0.34	0.32	0.18	0.18
4	0.30	0.30	0.31	0.31	0.28	0.14	0.14
5	0.28	0.28	0.28	0.28	0.26	0.12	0.12
6	0.24	0.24	0.26	0.26	0.24	0.12	0.12
7	0.22	0.22	0.24	0.24	0.22	0.12	0.12
8	0.20	0.20	0.23	0.23	0.20	0.10	0.10
9	0.18	0.18	0.21	0.21	0.18	0.10	0.10
10	0.14	0.14	0.19	0.19	0.14	0.10	0.10
11	0.13	0.13	0.18	0.18	0.13	0.10	0.10
12	0.12	0.12	0.16	0.16	0.12	0.06	0.06
13	0.11	0.10	0.14	0.14	0.11		
14	0.06	0.06	0.13	0.13	0.06		
15			0.12	0.12			
16			0.10	0.11			
17			0.06	0.06			
Total	3.14	3.13	3.79	3.78	3.03	1.60	1.60

API EXTERNAL & INTERNAL - RECOMMENDED NO. OF PASSES

No. of Passes	Extreme Line Casing 6 TPI 1.5 IPF		Extreme Line Casing 5 TPI 1.5 IPF		Round API 0.75 IPF 8 TPI		Round API 0.75 IPF 10 TPI	
	External	Internal	External	Internal	External	Internal	External	Internal
1	0.23	0.25	0.25	0.25	0.25	0.25	0.25	0.25
2	0.20	0.20	0.22	0.23	0.22	0.22	0.20	0.20
3	0.16	0.17	0.20	0.21	0.20	0.20	0.17	0.17
4	0.15	0.15	0.18	0.19	0.18	0.18	0.15	0.15
5	0.13	0.14	0.15	0.16	0.16	0.16	0.14	0.14
6	0.12	0.13	0.14	0.15	0.15	0.15	0.13	0.13
7	0.11	0.12	0.13	0.14	0.14	0.14	0.12	0.12
8	0.10	0.12	0.12	0.13	0.13	0.13	0.12	0.12
9	0.06	0.10	0.11	0.12	0.12	0.12	0.10	0.10
10		0.06	0.10	0.11	0.11	0.11	0.06	0.06
11			0.10	0.11	0.11	0.11		
12			0.06	0.10	0.06	0.06		
13				0.06				
Total	1.26	1.44	1.76	1.96	1.83	1.83	1.44	1.44

THREADING

THREADING

TAPER PIPE THREAD: NPT / ANSI/ASME B 1.20.1-1983 - INTERNAL THREAD
 AMERICAN NATIONAL STANDARD TAPER PIPE THREADS

Thread Size				Recommended Tools	
	Pitch TPI	Pitch MM	Profile Depth	Insert	Toolholder
NPT 1/16	27	0.941	0.69	06IR 27NPT	S12H SXFNR 06
NPT 1/8	27	0.941	0.69	08IR 27NPT	S16K SXFNR 08
NPT 1/4	18	1.411	1.05	08IR 18NPT	S16K SXFNR 08
NPT 3/8	18	1.411	1.05	11IR 18NPT	S10K SXFNR 11
NPT 1/2	14	1.814	1.37	16IR 14NPT	S13M SXFNR 16
NPT 3/4	14	1.814	1.37	16IR 14NPT	S16P SXFNR 16
NPT 1	11.5	2.209	1.68	16IR 11.5NPT	S20P SXFNR 16
NPT 1 1/4	11.5	2.209	1.68	16IR 11.5NPT	S25R SXFNR 16
NPT 1 1/2	11.5	2.209	1.68	16IR 11.5NPT	S32S SXFNR 16
NPT 2	11.5	2.209	1.68	16IR 11.5NPT	S32S SXFNR 16
NPT 2 1/2	8	3.175	2.45	16IR 8NPT	S40T SXFNR 16
NPT 3	8	3.175	2.45	16IR 8NPT	S40T SXFNR 16
NPT 3 1/2	8	3.175	2.45	16IR 8NPT	S40T SXFNR 16
NPT 4	8	3.175	2.45	16IR 8NPT	S40T SXFNR 16
NPT 5	8	3.175	2.45	16IR 8NPT	S40T SXFNR 16

PARALLEL PIPE THREAD / BSP (G) - INTERNAL THREAD





Thread Size				Bore Diameter	Recommended Tools	
	Pitch TPI	Pitch MM	Profile Depth		Insert	Toolholder
G1/16	28	0.907	0.581	6,561	06IR 28W	S12H SXFNR 06
G1/8	28	0.907	0.581	8,556	08IR 28W	S16K SXFNR 08
G1/4	19	1.337	0.856	11,445	08IR 19W	S16K SXFNR 08
G3/8	19	1.337	0.856	14,950	11IR 19W	S10K SXFNR 11
G1/2	14	1.814	1.162	18,631	16IR 14W	S13M SXFNR 16
G5/8	14	1.814	1.162	20,587	16IR 14W	S16P SXFNR 16
G3/4	14	1.814	1.162	24,117	16IR 14W	S16P SXFNR 16
G7/8	11	1.814	1.162	27,877	16IR 14W	S20P SXFNR 16
G1	11	2,309	1,479	30,291	16IR 11W	S20P SXFNR 16
G1 1/8	11	2,309	1,479	34,939	16IR 11W	S25R SXFNR 16
G1 1/4	11	2,309	1,479	38,952	16IR 11W	S25R SXFNR 16
G1 1/2	11	2,309	1,479	44,845	16IR 11W	S32S SXFNR 16
G1 3/4	11	2,309	1,479	50,788	16IR 11W	S32S SXFNR 16
G2	11	2,309	1,479	56,656	16IR 11W	S32S SXFNR 16

TAPER PIPE THREAD: NPTF / ANSI B 1.20.3-1976 - INTERNAL THREAD
 AMERICAN NATIONAL STANDARD DRYSEAL PIPE THREADS

Thread Size				Recommended Tools	
	Pitch TPI	Pitch MM	Profile Depth	Insert	Toolholder
NPTF 1/16	27	0.941	0.64	06IR 27NPTF	S12H SXFNR 06
NPTF 1/8	27	0.941	0.64	08IR 27NPTF	S16K SXFNR 08
NPTF 1/4	18	1.411	1.00	08IR 18NPTF	S16K SXFNR 08
NPTF 3/8	18	1.411	1.00	11IR 18NPTF	S10K SXFNR 11
NPTF 1/2	14	1.814	1.35	16IR 14NPTF	S13M SXFNR 16
NPTF 3/4	14	1.814	1.35	16IR 14NPTF	S16P SXFNR 16
NPTF 1	11.5	2.209	1.64	16IR 11.5NPTF	S20P SXFNR 16
NPTF 1 1/4	11.5	2.209	1.64	16IR 11.5NPTF	S25R SXFNR 16
NPTF 1 1/2	11.5	2.209	1.64	16IR 11.5NPTF	S32S SXFNR 16
NPTF 2	11.5	2.209	1.64	16IR 11.5NPTF	S32S SXFNR 16
NPTF 2 1/2	8	3.175	2.39	16IR 08NPTF	S40T SXFNR 16
NPTF 3	8	3.175	2.39	16IR 08NPTF	S40T SXFNR 16

TAPER PIPE THREAD / B SPT (RC) - INTERNAL THREAD

Thread Size				Bore Diameter	Recommended Tools	
	Pitch TPI	Pitch MM	Profile Depth		Insert	Toolholder
Rc 1/16	28	0.907	0.581	6,561	06IR 28BSPT	S12H SXFNR 06
Rc 1/8	28	0.907	0.581	8,556	08IR 28BSPT	S16K SXFNR 08
Rc 1/4	19	1.337	0.856	11,445	08IR 19BSPT	S16K SXFNR 08
Rc 3/8	19	1.337	0.856	14,950	11IR 19BSPT	S10K SXFNR 11
Rc 1/2	14	1.814	1.162	18,631	16IR 14BSPT	S13M SXFNR 16
Rc 5/8	14	1.814	1.162	20,587	16IR 14BSPT	S16P SXFNR 16
Rc 3/4	14	1.814	1.162	24,117	16IR 14BSPT	S16P SXFNR 16
Rc 7/8	14	1.814	1.162	27,877	16IR 14BSPT	S20P SXFNR 16
Rc 1	11	2,309	1,479	30,291	16IR 11BSPT	S20P SXFNR 16
Rc 1 1/8	11	2,309	1,479	34,939	16IR 11BSPT	S25R SXFNR 16
Rc 1 1/4	11	2,309	1,479	38,952	16IR 11BSPT	S25R SXFNR 16
Rc 1 1/2	11	2,309	1,479	44,845	16IR 11BSPT	S32S SXFNR 16
Rc 1 3/4	11	2,309	1,479	50,788	16IR 11BSPT	S32S SXFNR 16
Rc 2	11	2,309	1,479	56,656	16IR 11BSPT	S32S SXFNR 16

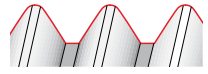
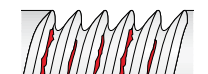
Problem Problema	Possible Cause Causa Possível Causa Possible	Solution Solução Solución
 <p>Increased flank wear Desgaste da aresta Desgaste del flanco</p>	<ul style="list-style-type: none"> Cutting speed too high Velocidade de corte alta Alta velocidad de corte Depth of cut too low/ too many passes Profundidade de corte demasiado baixa / demasiados passos Profundidad de corte demasiado baja / demasiados pasos Unsuitable carbide grade Grau desajustado Grado desajustado Insufficient cooling Refrigeração insuficiente Insuficiente refrigeración 	<ul style="list-style-type: none"> Reduce cutting speed / Use coated insert Reduza a velocidade de corte / Use uma pastilha revestida Reducir la velocidad de corte / Utilice un inserto recubierto Increase the depth of cut per pass Aumente a profundidade de corte por passo Aumento de la profundidad de corte por paso Use a coated carbide grade Use um grau revestido Utilice un grado recubierto Increase coolant flow rate Aumente o fluxo de refrigeração Aumentar el flujo de refrigeración
 <p>Uneven cutting edge wear Deformação da aresta de corte Deformación del flanco de corte</p>	<ul style="list-style-type: none"> Incorrect helix angle Ângulo da hélice incorrecto Ângulo de hélice incorrecta Wrong infeed method Método de avanço incorrecto Método incorrecto de avance 	<ul style="list-style-type: none"> Choose the correct anvil Escolha o ângulo correcto Elija el ángulo correcto Use the Alternating Flank Infeed method Use um método alternativo de avanço Utilizar un método alternativo de avance
 <p>Extreme plastic deformation Deformação plástica extrema Deformación plástica extrema</p>	<ul style="list-style-type: none"> Depth of cut too large Profundidade de corte demasiado larga Profundidad de corte demasiado grande Insufficient cooling Refrigeração insuficiente Insuficiente refrigeración Cutting speed too high Velocidade de corte alta Alta velocidad de corte Unsuitable carbide grade Grau não aconselhável Grado no es aconsejable Nose radius too small Raio demasiado pequeno Radio demasiado pequeno 	<ul style="list-style-type: none"> Decrease depth of cut / Increase number of passes Diminua a profundidade de corte / Aumente o número de passos Reducir la profundidad de corte / Aumentar el número de pasos Increase coolant flow rate Aumente o fluxo de refrigeração Aumentar el flujo de refrigeración Reduce cutting speed Reduza a velocidade de corte Reducir la velocidad de corte Use a tougher carbide Use um grau mais macio Usar un grado más suave Use an insert with a larger radius, if possible Use uma pastilha com um raio mais largo, se possível Utilice un inserto con un radio más amplio, si es posible
 <p>Cutting edge breakage Quebra da aresta de corte Rotura del flanco de corte</p>	<ul style="list-style-type: none"> Depth of cut too large Profundidade de corte demasiado larga Profundidad de corte demasiado grande Extreme plastic deformation Deformação plástica extrema Deformación plástica extrema Insufficient cooling Refrigeração insuficiente Insuficiente refrigeración Unsuitable carbide grade Grau não aconselhável Grado no es aconsejable Instability Instabilidade Inestabilidad 	<ul style="list-style-type: none"> Decrease depth of cut / Increase number of passes Diminua a profundidade de corte / Aumente o número de passos Reducir la profundidad de corte / Aumentar el número de pasos Use a tougher carbide Use um grau mais macio Usar un grado más suave Increase flow rate and/ or correct flow direction Aumento o fluxo ou melhore o direcionamento da refrigeração Aumentar o mejorar la dirección del flujo de la refrigeración Use a tougher carbide Use um grau mais macio Usar un grado más suave Check stability of the system Verifique a estabilidade do sistema Compruebe la estabilidad del sistema
 <p>Built-up edge Aresta postiza Filos recrescidos</p>	<ul style="list-style-type: none"> Incorrect cutting speed Velocidade de corte incorrecta Velocidad de corte incorrecta Unsuitable carbide grade Grau não aconselhável Grado no es aconsejable 	<ul style="list-style-type: none"> Change the cutting speed Altere a velocidade de corte Cambiar la velocidad de corte Use a coated carbide Utilize um grau revestido Utilice un grado recubierto
 <p>Thread profile is too shallow Perfil da rosca muito irregular Perfil de la rosca muy irregular</p>	<ul style="list-style-type: none"> The tool is not at the workpiece axis height A pastilha não está a maquinar a crista da rosca El inserto no está mecanizando Insert is not machining the thread crest A ferramenta não está posicionada correctamente La herramienta no está colocada correctamente a cresta de la rosca Worn insert Pastilha gasta Inserto pasado 	<ul style="list-style-type: none"> Change tool height Altere o posicionamento em altura da ferramenta Cambiar la posición en la altura de la herramienta Measure the workpiece diameter Medir o diâmetro correcto da peça de trabalho Medir el diámetro de la pieza de trabajo Change the cutting edge sooner Mudar antecipadamente a aresta de corte Cambiar el flanco de corte en anticipo
 <p>Thread profile is too shallow Má qualidade superfície Acabado de superficie malo</p>	<ul style="list-style-type: none"> Cutting speed too low Velocidade de corte baixa Velocidad de corte baja Wrong anvil Colchão errado Colchón cambiado Flank infeed method is not appropriate Posição de avanço inapropriada Posición de avance inadecuada 	<ul style="list-style-type: none"> Increase cutting speed Aumente a velocidade de corte Aumentar la velocidad de corte Choose correct anvil Escolha um colchão mais apropriado Elija un colchón más apropiado Use the alternate flank or radial infeed method Use um método de flanqueamento ou radial alternativo Utilice un método flanqueamento o radial alternativo

Steel, Ferritic and Martensitic Stainless Steel

ISO	PSM	Material Example	Description	R _m (N/mm ²)	kcX (N/mm ²)	m _c
P	1	Ck50	Structural steels; ordinary carbon steels with low to medium carbon content (<0,5%C); soft carbon steel; free cutting steel.	<500	1500	0.25
	2	42CrMnNiMo 4	Normal tool steels; harder steels for toughening; Martensitic stainless steels; Carbon steels with high carbon content (>0,5%C); Ferritic and martensitic stainless steels.	550<900	1900	0.24
	3	X40CrMoV51	Normal tool steels; Harder steels for toughening; Martensitic stainless steels; Difficult tool steels; High-alloy steels with high hardness; Martensitic stainless steels.	900<1200	2000	0.24

Easy-cutting, Austenitic and Duplex Stainless Steel

ISO	PSM	Material Example	Description	R _m (N/mm ²)	kcX (N/mm ²)	m _c
M	4	X8CrNiS189	Easy-cutting stainless steels; Free-cutting stainless steels; Calcium-treated stainless steels.		1750	0.22
	5	X2CrNiMo17122	Moderately to difficult stainless steels: Austenitic and duplex.		2050	0.20
	6	X2CrNiMoN2253	Very difficult stainless steels: Austenitic and duplex.		2150	0.20

Cast Iron

ISO	PSM	Material Example	Description	R _m (N/mm ²)	kcX (N/mm ²)	m _c
K	7	GJL-150	Medium / hard cast iron; Grey cast iron.		1150	0.22
	8	GJL-250	Low-alloy cast iron; Malleable cast iron; Nodular cast iron.		1225	0.25
	9	GJL-350	Difficult high-alloy cast iron; Difficult malleable cast iron; Nodular cast iron		1470	0.30

Aluminium and Non-Ferrous

ISO	PSM	Material Example	Description	R _m (N/mm ²)	kcX (N/mm ²)	m _c
N	10	AW7075 AISI12 CuZn37	Aluminium alloys: Low Si Aluminium alloys; High Si Copper alloys			

Heat Resistant Super Alloys

ISO	PSM	Material Example	Description	R _m (N/mm ²)	kcX (N/mm ²)	m _c
S	11	Inconel 718	Ni-based super-alloys Titanium alloys		3300 1450	0.24 0.23

Please note that the R_m value is only for selection of the material group and when the material has been heat treatment or other methods that increase the strength of the material.

ISO	DIN	W.-Nr	EN	EN-Nr	AFNOR	BS	UNI	
1	20Mn5	1.1133			20M5	120M19	G22Mn3	
	30Mn5	1.1165	G28Mn6	1.1165		120M36		
	C10	1.0301	C10	1.0301	AF34C 10;XC10	045M10	C10	
	C15	1.0401			AF37C 12;XC18	080M15	C15;C16	
	C22	1.0402	C22+N	1.0402	C20	050A20	C20;C21	
	C25	1.0406	C25+N	1.0406	AF50C30	070M26	C25	
	Ck10	1.1121	C10E	1.1121	XC10	040A10	C10	
	Ck15	1.1141	C15R	1.1141	XC15;XC18	080M15	15;C16	
	Ck22	1.1151	C22E	1.1151	XC25;XC18	040A22	C20	
	Ck25	1.1158			XC25	060A25	C25	
	St37-2	1.0037	S235JR	1.0037	E24-2		Fe360B	
	St37-3	1.0116	S235JRG2	1.0038	E24-3;E24-4	4360-40C	Fe360DFF	
	St44-2	1.0044	S275J0H	1.0149	E28-2	4360-43B	Fe430BFN	
	St44-3N	1.0144	S275J2G3	1.0144	E28-3;E28-4	4360-43C	Fe430DFF	
	10S20	1.0721	10S20	1.0721	10F1	210M15	CF10S20	
	10SPb20	1.0722			10PbF2		CF10SPb20	
	15S20	1.0723	15SMn13	1.0725		210A15		
	35S20	1.0726	35S20	1.0726	35MF4	212M36		
	46S20	1.0727	46S20	1.0727	45MF4	212M44		
	60S20	1.0728	60S20	1.0728	60MF4			
	9S20	1.0711				220M07	CF9S22	
	9SMn28	1.0715	11SMn30	1.0715	S250	230M07	CF9SMn28	
	9SMn36	1.0736	11SMn37	1.0736	S300	240M07	CF9SMn36	
	9SMnPb28	1.0718	11SMnPb30	1.0718	S250Pb		CF9SMnPb28	
	9SMnPb36	1.0737	11SMnPb37	1.0737	S300Pb		CF9SMnPb36	
	14Ni6	1.5622			16N6		14Ni6	
	16Mo5	1.5423				1503-245-420	16Mo5	
	36Mn5	1.1167	G28Mn6+QT	1.1165	40M5	150M36		
	40Mn4	1.1157			35M5	150M36		
	C30	1.0528			C30	080A30		
	C35	1.0501	C35+N		AF55C35	060A35	C35	
	C40	1.0511	C40+N		AF60C40	080M40	C40	
	C45	1.0503	E335	1.0503	AF65C45	80M46	C45	
	C50	1.0540	C50+N		C50	080M50		
	Ck30	1.1178	C30E	1.1178		060A30		
	Ck35	1.1181	C35E	1.1181	XC38H1;XC32	080M36	C35	
	Ck40	1.1186	C40E	1.1186	XC42H1	080M40	C40	
	Ck50	1.1206	C50E	1.1206	XC48H1	080M50		
	Ck55	1.1203	C55E	1.1203	XC55	070M55	C50	
	St52-3	1.0570	S355JR	1.0570	E36-3;E36-4	4360-50C	Fe510B;C;D	
	St70-2	1.0535	E360	1.0070	A70-2		Fe690	
	2	12Ni19	1.5680			Z18N5		
		13Cr2	1.7012					
		13CrMo44	1.7335	13CrMo45	1.7335	15CD3.5	1501-620Gr.27	14CrMo45
		14MoV63	1.7715				1503-660-440	
14NiCr10		1.5732			14NC11		16NiCr11	
14NiCr14		1.5752	14NiCr14	1.5752	12NC15	655M13		
15Cr3		1.7015			12C3	523M15		
15CrMo5		1.7262			12CD4		12CrMo4	
15CrMoV59		1.8521						
15CrNi6		1.5919			16NC6	S107	16CrNi4	
15Mo3		1.5415	16Mo3	1.5415	15D3	1501-240	16Mo3	
15NiCr14		1.2735			10NC12			
16CrMo44		1.7337			15CD4.5	1501-620Gr.27	14CrMo45	
16MnCr5		1.7131	16MnCr5	1.5715	16MC5	527M17	16MnCr5	
16MnCrS5		1.7139	16MnCrS5	1.7139				
18CrNi8		1.5920			20NC6			
18CrNiMo6		1.6587	17CrNiMo6	1.6587	18NCD6	820A16	18NiCrMo7	
20CrMo2		1.7311						
20CrMo5		1.7264	20CrMo5	1.7264	18CD4			
20MnCr5		1.7147	20MnCr5	1.7147	20MC5		20MnCr5	
20MnCrS5		1.7149	20MnCrS5	1.7149	20MnCrS5			
20MoCr4		1.7321						
20MoCrS4		1.7323						
21MnCr5		1.2162			20NC5			

JIS	SS	UNS	AISI/ASTM	Misc. Brand	Condition	Form	Structure
SMnC420		G10220	1022;1518				
SMn1H;SCMn2		G13300	1330				
S10C		G10100	1010				
	1350	G10170	1015				
	1450	G10200	1023				
S25C			1025				
S10C;S9CK	1265	G10100	1010				
S15C;S15CK	1370	G10170	1015				
S22C;S20CK			1022				
S25C		G10250	1025				
STKM12C	1311						
	1312;1313		A573Gr.58				
SM41B	1412		A570Gr.40				
SM41C	1412;1414		A573Gr.70				
			1108				
			11L08				
SUM32	1922						
	1957	G11400	1140				
	1973	G11460	1146				
SUM21		G12120	1212				
SUM22	1912	G12130	1213				
		G12150	1215				
SUM22L	1914	G12134	12L13				
	1926	G12144	12L14				
			A350-LF5				
SB450M		G45200	4520				
SMn438(H);SCMn3	2120	G13350	1335				
		G10390	1039				
S30C							
	1550	G10350	1035				
S40C			1040				
S45C	1650	G10430	1045				
S50C			1049				
S30C			1030				
S35C	1572	G10340	1035				
S40C			1040				
			1050				
S55C			1055				
SM50YA	2172;2132						
	1655		1055				
			2515				
	2216		A182-F11;F12				
SNC415(H)			3415				
SNC815(H)		G33106	3310;9314				
SCr415(H)		G50150	5015				
SCM415(H)							
			4320				
	2912		A204Gr.A				
SNC22		T51606	P6				
	2216		A387Gr.12Cl.2				
SCR415	2511	G51170	5115				
SCM421							
SMnC420(H)		G51200	5120				
SMnC21H			5120H				
SCR420H							

ISO	DIN	W.-Nr	EN	EN-Nr	AFNOR	BS	UNI
2	21NiCrMo2	1.6523	20NiCrMoS22	1.6526	20NCD2	805M20	20NiCrMo2
	23CrMoB33	1.7271					
	25CrMo4	1.7218	25CrMo4	1.7218	25CD4S	1717CDS110	25CrMo4(KB)
	25MoCr4	1.7325					
	25MoCrS4	1.7326					
	28Cr4	1.7030	28Cr4	1.7030		530A30	
	28NiCrMo4	1.6513					
	30CrMoV9	1.7707					
	30CrNiMo8	1.6580			30CND8	823M30	30NiCrMo8
	31CrMoV9	1.8519	31CrMoV9	1.8519	32CDV12		
	31NiCr14	1.5755			30NC11	653M31	
	32Cr2	1.7020					
	32CrMo12	1.7361			30CD12	722M24	32CrMo12
	34Cr4	1.7033	34Cr4	1.7033	32C4	530A32	34Cr4(KB)
	34CrMo4	1.7220	34CrMo4	1.7220	35CD4	708A37	35CrMo4
	35CrMo4	1.2330			34CD4	708A37	35CrMo4
	35NiCr18	1.5864					
	36CrNiMo4	1.6511	36CrNiMo4+TA		40NCD3	816M40	38NiCrMo4(KB)
	36NiCr10	1.5736			35NC11		35NiCr9
	36NiCr6	1.5710			35NC6	640A35	
	37Cr4	1.7034			38C4	530A36	38Cr4
	37MnSi4	1.5122					
	38Cr2	1.7003	38Cr2	1.7003	38C2		38Cr2
	38MnSi4	1.5120					
	39CrMoV139	1.8523				897M39	36CrMoV139
	40CrMnMo7	1.2311					
	40CrMnMoS86	1.2312			40CMD8S		
	40CrMnNiMo8	1.2738			40CND8		
	41Cr4	1.7035	41Cr4	1.7035	42C4	530M40	41Cr4
	41CrMo4	1.7223			42CD4TS	708M40	41CrMo4
	42Cr4	1.7045			42C4TS	530A40	41Cr4
	42CrMo4	1.7225	42CrMo4	1.7225	42CD4	708M40	42CrMo4
	42CrV6	1.7561					
	42MnV7	1.5223					
	43CrMo4	1.3563					
	44Cr2	1.3561					
	46Cr2	1.7006			42C2		45Cr2
	46MnSi4	1.5121					
	48CrMo4	1.3565					
	50CrMo4	1.7228				708A47	
	50CrV4	1.8159	50CrV4	1.8159	50CV4	735A50	51CrV4
	50MnSi4	1.5131	50MnSi4	1.5131			
	53MnSi4	1.5141					
	55Cr3	1.7176	55Cr3	1.7176	55C3	527A60	55Cr3
	55Si7	1.0904	55SiCr7	1.7100	55S7	250A53	55Si8
	58SiCr8	1.2103					
	60SiCr7	1.0961			60SC7		60SiCr8
	62SiMnCr4	1.2101					
	C45W	1.1730			Y342		
	C55W	1.1820					
	C60	1.0601	C60+N	1.0601	CC55	080A62	C60
	C60W	1.1740			Y355		
	C67W	1.1744					
	C70W1	1.1520					
	C70W2	1.1620					
	C75W	1.1750	C75W	1.1750		BW1A	
	C80W1	1.1525			Y190;Y180		C80KU
	C80W2	1.1625			Y180	BW1B	C80KU
	C85W	1.1830			Y390		
	Ck45	1.1191	C45E	1.1191	XC42	080M46	C45
Ck60	1.1221	C60E	1.1221	XC60	080A62	C60	
Ck67	1.1231	C67S	1.1231	XC68	060A67	C70	
Ck75	1.1248	C75S	1.1248	XC75	060A78	C75	
GS-50CrV4	1.8159						
St60-2	1.0060	E335	1.0060	A60-2	4360-SSE;SSC	Fe590;Fe60-2	

JIS	SS	UNS	AISI/ASTM	Misc. Brand	Condition	Form	Structure
SUS410	2506	G86170	8620				
SUS405							
SUH442	2225	G41300	4130				
SUS410							
SUS430F							
SUS416			5130				
SUS410J1							
SCS5							
SUH409							
SUS403	2240						
SUS430		G51320	5132				
SUS405	2234	G41350	4135;4137				
	2234	T51620	4135				
SUS430LX							
SUS430LX		G98400	9840				
			3435				
SUJ2			3135				
SKS3			5135				
SKS43							
SKS31							
			P20				
			P20+S				
			P20+Ni				
		G51400	5140				
	2244	G41420	4142;4140				
	2245*)		5140				
	2244	G41400	4142;4140				
SNCM447							
SNCM240							
SNCM439							
SACM645			5045				
			5045				
		G41470	4150				
	2230	H61500	6150				
	2253	G51550	5155				
	2085;2090		9255				
			9262				
SK3							
SK2							
SK1		G10600	1060				
SUP4							
		T72301	W1				
			W108				
SUS420J1							
SUS431	1672	G10420					
	1665;1678	G10640	1064				
SUS420J2	1770	G10700	1070				
	1774;1778	G10780	1078;1080				
			6150H				
SUS420							

ISO	DIN	W.-Nr	EN	EN-Nr	AFNOR	BS	UNI	
5	X2CrNiN1911	1.4311	X2CrNiN1810	1.4311	Z2CN18.10Az	304S62	X2CrNiN1811	
	X5CrNiMo17133	1.4436	X5CrNiMo17133	1.4436	Z6CND18.12.03	316S33	X5CrNiMo17132	
	X6CrNi189	1.4308	X5CrNi19 10	1.4308	Z6CN18.10M	304C15		
	X6CrNiMoNb17122	1.4580	X6CrNiMoNb17122	1.4580	Z6CNDNb17.12	318S17	X6CrNiMoNb1712	
	X6CrNiMoTi17122	1.4571	X6CrNiMoTi17122	1.4571	Z6CNDT17.12	320S31	X6CrNiMoTi1712	
	X15CrNiSi2520	1.4841	X15CrNiSi2520	1.4841	Z15CNS25.20	314S25	X16CrNiSi2520	
	X5CrNiMo1810	1.4401	X5CrNiMo17122	1.4401	Z3CND17.11.1	316S31	X5CrNiMo1712	
6	X1CrNiMoN20187	1.4547	X1CrNiMoN20187	1.4547		X1CrNiMoN20187	X1CrNiMoN20187	
	X1NiCrMoCuN31274	1.4563	X1NiCrMoCuN31274	1.4563				
	X10NiCrAlTi3220	1.4876	X10NiCrAlTi3220	1.4876	Incoloy800	Z10NC32.21		
	X12NiCrSi3616	1.4864	X12NiCrSi3616	1.4864	Z20NCS33.16	NA17		
	X2CrNiMoN2574	1.4410	X2CrNiMoN 2574	1.4410	Z3CND25.07Az		X2CrNiMoN2574	
	X2CrMoNiCuN2563	1.4507	X2CrMoNiCuN2563	1.4507				
	X2CrNiMoCuWN2574	1.4501	X2CrNiMoCuWN2574	1.4501	Z3CND25.06Az			
	X2CrNiMoN17122	1.4406	X2CrNiMoN17112	1.4406	Z2CND17.12Az	316S61	X2CrNiMoN1712	
	X2CrNiMoN17133	1.4429	X2CrNiMoN17133	1.4429	Z2CND17.13Az	316S62	X2CrNiMoN17133	
	X2CrNiMoN17133	1.4439	X2CrNiMoN17135	1.4439	Z3CND18.14.05Az	(316S63)		
	X2CrNiMoN225	1.4462	X2CrNiMoN 2253	1.4462	Z2CND22.05Az	332S15	X2CrNiMoN225	
	X2CrNiMoN225	1.4462	X2CrNiMoN225	1.4462	Z2CND22.05Az	318S13	X2CrNiMoN225	
	X2CrNiMoN25227	1.4652	X1CrNiMoN25228	1.4652				
	X2CrNiN234	1.4362	X2CrNiN234	1.4362				
	X2NiCrMoCu25205	1.4539	X2NiCrMoCu25205	1.4539	Z2NCDU2520	904S13		
	X2NiCrMoCu25205	1.4539	X1NiCrMoCu25205	1.4539				
	X4CrNiCuNb164	1.4540	X4CrNiCuNb164	1.4540	Z4CNUNb16.4M			
	X4CrNiMo2752	1.4460	X3CrNiMo2752	1.4460	Z3CND25.7Az		X3CrNiMo2752	
	X5CrNiCuNb174	1.4542	X5CrNiCuNb164	1.4548	Z6CNU17.4			
	7	GG-10	0.6100	EN-GJL-100	0.6100	Ft10D	Grade100	G10
GG-15		0.6150	EN-GJL-150	0.6150	Ft15D	Grade150	G15	
GGG-35.3		0.7033	EN-GJS-350-22	0.7033	FGS370-17	Grade350/22		
GGG-40		0.7040	EN-GJS-400-15	0.7040	FGS400-12	Grade420/12	GS400-12	
GGG-40.3		0.7043	EN-GJS-400-18	0.7043	FGS-370-17	Grade370/17	GSO42/17	
GTS-35-10			EN-GJMB-350-10	0.8135	B340/12	B340/12	B35-12	
GTS-45-06			EN-GJMB-450-6	0.8145	P440/7	P440/7	P45-06	
GTS-55-04			EN-GJMB-550-4	0.8155	P540/5	P540/5	P55-04	
8		GG-20	0.6200	EN-GJL-200	0.6200	Ft20D	Grade220	G20
		GG-25	0.6250	EN-GJL-250	0.6250	Ft25D	Grade260	G25
	GGG-50	0.7050	EN-GJS-500-7	0.7050	FGS500-7	Grade500/7	GS500-7	
	GGG-60	0.7060	EN-GJS-600-3	0.7060	FGS600-3	Grade600/3	GS600-3	
	GGG-NiCr202	0.7660	EN-GJSA-XNiCr20-2	0.7660	FGSNi20Cr2	GradeS2		
	GGG-NiCr203	0.7661	EN-GJSA-XNiCr20-3	0.7661	FGSNi20Cr3	GradeS2B		
	GGG-NiMn137	0.7652	EN-GJSA-XNiMn13-7	0.7652	FGSNi13Mn7	GradeS6		
	GGL-NiCr202	0.6660	EN-GJLA-XNiCr20-2	0.6660	FGLNi20Cr2	GradeF2		
	GGL-NiCr203	0.6661	EN-GJLA-XNiCr20-3	0.6661	FGLNi20Cr3			
	GTS-65-02		EN-GJMB-600-3	0.8165	P570/3	P570/3	P65-02	
9	GG-30	0.6300	EN-GJL-300	0.6300	Ft30D	Grade300	G30	
	GGG-70	0.7070	EN-GJS-700-2	0.7070	FGS700-2	Grade700/2	GS700-2	
	GGL-NiCuCr1562	0.6655	EN-GJLA-XNiCuCr15-6-2	0.6655	FGLNi15Cu6Cr2	GradeF1		
	GGL-NiCuCr1563	0.6656	EN-GJLA-XNiCuCr15-6-3	0.6656	FGLNi15Cu6Cr3			
	GTS-70-02		EN-GJMB-700-2	0.8170	P690/2	P690/2	P70-02	
	GG-35	0.6350	EN-GJL-350	0.6350	Ft35D	Grade350	G35	
	GG-40	0.6040	-	0.6040	Fgl400	Grade400		
	GGG-80	0.7080	EN-GJS-800-2	0.7080	FGS800-2		GS800-2	
	GGG-Ni22	0.7670	EN-GJSA-XNi22	0.7670	FGSNi22			
	GGG-Ni35	0.7683	EN-GJSA-XNi35	0.7683	FGSNi35			
	GGG-NiCr301	0.7677	-	0.7677	FGSNi30Cr1			
	GGG-NiCr303	0.7676	EN-GJSA-XNiCr30-3	0.7676	FGSNi30Cr3	GradeS3		
	GGG-NiCr353	0.7683	EN-GJSA-XNiCr35-3	0.7683	FGSNi35Cr3			
	GGG-NiMn234	0.7673	EN-GJSA-XNiMn23-4	0.7673	FGSNi23Mn4	GradeS2M		
	GGG-NiSiCr2052	0.7665	EN-GJSA-XNiSiCr20-5-2	0.7665	FGSNi20Si5Cr2			
	GGG-NiSiCr3055	0.7680	EN-GJSA-XNiSiCr30-5-5	0.7680	FGSNi30Si5Cr5			
	GGL-NiCr303	0.6676	EN-GJLA-XNiCr30-3	0.6676	FGLNi30Cr3	GradeF3		
	GGL-NiSiCr2053	0.6667	EN-GJLA-XNiSiCr20-5-3	0.6667	FGLNi20Si5Cr3			
GGL-NiSiCr3055	0.6680	-	0.6680	FGLNi30Si5Cr5				

JIS	SS	UNS	AISI/ASTM	Misc. Brand	Condition	Form	Structure
SUS304LN	2371	S30453	304LN				Austenite
SUS316	2343	S31600	316				Austenite
SCS13	2333		CF8				Austenite
		S31640	316Cb				Austenite
SUS316Ti	2350		316Ti				Austenite
SUH310		S31000	314;310				Austenite
SUS316	2347	S31600	316				Austenite
	2778	S31254		254SMO			Superaustenite
		N08028		Sanicro28			Superaustenite
NCF800		N08800		Alloy800	sol.treated		PH
SUH330		N08330	330	IncoloyDS			Austenite
	2328	S32750	F53	SAF2507			Superduplex
		S32550	255	Ferralium			Superduplex
		S32760	F55	Zeron100			Superduplex
SUS316LN		S31653	316LN				Austenite
SUS316LN	2375	S31653	316LN				Austenite
(SUS316LN)		(S31653)	(316LN)				Austenite
	2377	S31803	329LN	SAF2205			Duplex
SUS329J3L	2377	S32205	318	SAF2205			Duplex
		S32654		654SMO			Superaustenite
	2327	S32304	-	SAF2304			Duplex
	2562	N08904	904L				Superaustenite
	2564		CN7M				Superaustenite
		S15500	XM-12	15-5-PH	sol.treated		PH
SUS329J1	2324	S32900	329				Duplex
SCS24;SUS630		S17400	630	17-4-PH	sol.treated		Superaustenite
FC100	0110-00	F11401	A1820B				GCI
FC150	0115-00	F11601	A4825B				GCI
FCD350-22L	0717-15						DCI
FCD400-18L	0717-02	F32800	60-40-18				DCI
	0717-12	F32800	60-40-18				DCI
FCMB35-10	0815-00	F22200	A4732510				Martensite
PCMP45-06	0852-00	F23130	A22045008				Martensite
PCMP55-04	0854-00	F24130	A22060004				Martensite
FC200	0120-00	F12101	A4830B				GCI
FC250	0125-00	F12401	A4835B				GCI
FCD500-7	0727-02	F33800	A53680-55-6				DCI
FCD600-3	0732-03	F34100	A47680-60-03				DCI
		F43000	A436TypeD-2				Austenite
		F43001	A436TypeD-2B				Austenite
	0772-00	-	-				Austenite
	0523-00	F41002	A436 Type2				Austenite
		F41003	A436Type2b				Austenite
PCMP60-03	0856-00	F24830	A22070003				Martensite
FC300	0130-00	F13101	A4845B				GCI
FCD700-2	0737-01	F34800	A536100-70-03				DCI
		F41000	A436 Type1				Austenite
		F41001	A436 Type1b				Austenite
PCMP70-02	0862-00	F26230	A22090001				Martensite
FC350	0135-00	F13502	A4850B				GCI
	0140-00	F14102	A27860B				GCI
FCD800-2		F36200	A536120-90-02				Martensite
			A439TypeD-2B				Austenite
		F43006	A439TypeD-5				Austenite
		F43004	A436TypeD-3A				Austenite
		F43003	A436TypeD-3				Austenite
		F43007	A436TypeD-5B				Austenite
		F43010	A439TypeD-2M				Austenite
		-	NicrosilalSpheronic				Austenite
		F43005	A439TypeD-4				Austenite
		F41004	A436 Type3				Austenite
			Nicrosilal				Austenite
			A436TypeD-4				Austenite

GENERAL TECHNICAL DATA

GENERAL TECHNICAL DATA

ISO	DIN	W.-Nr	EN	EN-Nr	AFNOR	BS	UNI
10	Al99	3.0205	AW-1200	Al99	A-4/1200	1C/1200	
	Al99.5	3.0255	AW-105 0A	Al99.5	A-5/1050A	1B/1050A	
	Al99.7	3.0275	AW-1070	Al99.7	A-7/1070		
	Al99.8	3.0285	AW-1080	Al99.8	A-8/1080	1A	
	AlCu2.5Mg0.5	3.1305			A-U2G	2L69	
	AlCuBiPb	3.1655	AW-2011	AlCuBiPb	A-U5PbBi/2011	FC1/2011	
	AlCuMg1	3.1325	AW-2024	AlCuMg1	A-U4G/2024	H14	
	AlCuMg2	3.1355			A-U4G1	2L97/98	
	AlCuSiMn	3.1255	AW-2014	AlCuSiMn	A-U4SG/2014	H15/2014	
	AlMg1	3.3315	AW-5005A	AlMg1	A-G0.6	N41/5005	
	AlMg1.5	3.3316			A-G1.5		
	AlMg1SiCu	3.3211	AW-6061	AlMg1SiCu	(6061)	H20	
	AlMg2.5	3.3523	AW-5052	AlMg2.5	A-G2.5C/5052	(N4)	
	AlMg2.7Mn	3.3537	AW-5454	AlMg2.7Mn	A-G2.5MC/5454	N51/5454	
	AlMg2Mn0.3	3.3525	AW-5251	AlMg2Mn0.3	A-G2M	N4/5251	
	AlMg2Mn0.8	3.3527	AW-5049	AlMg2Mn0.8	A-G2Mn0.8		
	AlMg3	3.3535	AW-5754	AlMg3	A-G3M		
	AlMg4.5	3.3345					
	AlMg4.5Mn	3.3547	AW-5083	AlMg4.5Mn	A-G4.5MC	N8/5083	
	AlMg4Mn	3.3545	AW-5086	AlMg4Mn	A-G4MC/5086	(N5/6)	
	AlMgSi0.5	3.3206	AW-6060	AlMgSi0.5	A-GS/6060	(H9)/(6060)	
	AlMgSi0.7	3.3210	AW-6063	AlMgSi0.7	A-GSUC/6061	(H10)	
	AlMgSi1	3.2315	AW-6082	AlMgSi1	A-SGM0.7/6082	H30/6082	
	AlMgSiPb	3.0615			A-SGPb		
	AlMn0.5Mg0.5	3.0505	AW-3105	AlMn0.5Mg0.5		N31	
	AlMn0.5Mg0.5	3.0525	AW-3005	AlMn0.5Mg0.5	A-MG0.5/3005		
	AlMn1	3.0515	AW-3103	AlMn1		N3/3103	
	AlMn1Cu	3.0517	AW-3003	AlMn1Cu	A-M1/3003		
	AlMn1Mg1	3.0526	AW-3004	AlMn1Mg1	A-M1G/3004		
	AlZn4.5Mg1	3.4335	AW-7020	AlZn4.5Mg1	A-Z5G/7020	H17/7020	
	AlZnMgCu0.5	3.4345			A-Z4GU		
	AlZnMgCu1.5	3.4365	AW-7075		A-Z5GU/7075	2L95/96	
	G-AlCu4Ti	3.1841	AC-21100	AlCu4Ti			
	G-AlCu4TiMg	3.1371	AC-21000	AlCu4TiMg	A-U5GT	2L91/92	
	G-AlMg3	3.3541	AC-51100	AlMg3	A-G3T		
	G-AlMg3Si	3.3241					
	G-AlMg5	3.3261	AC-51400	AlMg5(Si)			
	G-AlMg5	3.3555	AC-51400	AlMg5		LM5	
	G-AlMg9	3.3292	AC-51200	AlMg9			
	G-AlSi10Mg	3.2381	AC-43400	AlSi10Mg(Fe)	A-S10G	LM9	
	G-AlSi5Mg	3.2341	AC-42000		A-S7G	LM25	
	G-AlSi6Cu4	3.2151	AC-45000	AlSi6Cu4			
	G-AlSi7Mg	3.2371	AC-42100	AlSi7Mg	A-S7GO3	2L99	
	G-AlSi8Cu3	3.2161	AC-46200	AlSi8Cu3(Si)			
	G-AlSi9Mg	3.2373	AC-43200	AlSi9Mg	A-S10G		
	G-MgAg3Se2Zr1	3.5106					
	G-MgAl3Zn	3.5314	MG-P-62	MgAl3Zn	G-A3-Z1	MAG-E-111	
	G-MgAl6Mn	3.5662	MC21230	MgAl6Mn			
	G-MgAl6Zn	3.5612	MG-P-63	MgAl6Zn	G-A6-Z1	MAG-E-121	
	G-MgAl8Zn	3.5812	MG-P-61	MgAl8Zn	G-A9	MAG1-M	
	G-MgAl8Zn1	3.5812	MC21110	MgAl8Zn1	G-A92	A82	
	G-MgAl9Zn1	3.5912	MC21120	MgAl9Zn1	G-A92	MAG3	
	G-MgMn2	3.5200			G-M2	MAG-E-101	
	G-MgSe3Zn2Zr1	3.5103	MB65110	MgSe3Zn2Zr1	ZRE1	MAG6-TE	
	G-MgTh3Zn2Zr1	3.5105					
	G-AlSi10Mg(Cu)	3.2383	AC-43200	AlSi10Mg(Cu)			
	GD-AlSi12	3.2382	AC-44200	AlSi12			
			AC-46100	AlSi11Cu2(Fe)		LM9	
			AC-47100	AlSi12Cu1(Fe)			
				AlSi17Cu5			
	Cu		CW004A				
	CuAg0.1	2.1203	CW013A	CuAg0.1		Cu-Ag-4	
	CuAl10Fe	2.0940.01	CC331G		CuAl10Fe	AB1	
	CuAl10Fe5Ni5		CC333G-GZ				
	CuAl10Ni	2.0975.01	CC333G		CuAl10Ni5Fe5	AB2	
	CuAl10Ni5Fe4	2.0966	CW307G	CuAl10Ni5Fe4	CuAl10Ni	CA104	

JIS	SS	UNS	AISI/ASTM	Misc. Brand	Condition	Form	Structure
A1200	4010	AA1200					
(A1050)	4007	AA1050A					
	4005	AA1070A					
	4004	AA1080A					
		AA2117					
A2011	4355	AA2011					
A2017		AA2017A					
		AA2024					
	4338	AA2014					
	4106	AA5005A					
		AA5050B					
A6061		AA6061					
A5052	4120	AA5052					
A5454		AA5454					
		AA5251					
	4115	AA5049					
	4125	AA5754					
A5082		AA5082					
	4140	AA5083					
		AA5086					
	4103	AA6060					
(A6063)	4104,4107	AA6005					
	4212	AA6082					
		AA6012					
		AA3105					
-		AA3005					
	4054	AA3103					
A3003		AA3003					
-		AA3004					
	4425	AA7020					
		AA7022					
A7075		AA7075					
	4337	A02040	204				
		A05140	5140				
			5056A				
	4163						
	4253	A13600	B85				
	4244		B26				
	4245	A13560					
	4251		A380				
			359,2				
			4418				
	4633	AZ31B					
		AM60A					
		AZ61A					
		AZ80A					
	4637	AZ81A					
	4635	AZ91A/B	4437				
		M1A					
		B80	4442				
		B80					
ADC12			A413.2				
			A384.0				
ADC14		AA384					
	5015						
	5030	C11600					
	5710	C95200	CA952				
	5716	C95500	CA955				
C6301		C62730					

ISO	DIN	W.-Nr	EN	EN-Nr	AFNOR	BS	UNI
10	CuAl5	2.0916					
	CuAl5As	2.0918	CW300G	CuAl5As			
	CuAl8Fe3	2.0932					
	CuCr	2.1291					
	CuFe2P	2.1310	CW107C	CuFe2P			
	CuNi1.5Si	2.0853	CW109C	CuNi1Si			
	CuNi10Fe1Mn	2.0872		CuNi10Fe1Mn	CuNi10Fe1Mn	CN102	
	CuNi10Zn45						
	CuNi12Zn30Pb1	2.0780	CW406J	CuNi12Zn30Pb1			
	CuNi18Zn19Pb	2.0790		CW408J	CuNi18Zn19Pb1		
	CuNi18Zn19Pb1	2.0790	CW408J	CuNi18Zn19Pb1	CuNi18Zn19Pb1		
	CuNi18Zn20	2.0740	CW409J	CuNi18Zn20	CuNi18Zn20	NS106	
	CuNi18Zn27	2.0742	CW410J	CuNi18Zn27		NS107	
	CuNi20	2.0822					
	CuNi25	2.0830			CuNi25	CN105	
	CuNi30	2.0835					CuNi30
	CuNi30Fe2Mn2	2.0883					
	CuNi30FeMn						
	CuNi30Mn1Fe	2.0882	CW354H	CuNi30Mn1Fe	CuNi30Mn1Fe	CN107	
	CuNi3Si	2.0857	CW112C	CuNi3Si			
	CuNi44Mn1	2.0842			CuNi44Mn		
	CuNi5Fe1Mn				CuNi5Fe1Mn		
	CuNi9Sn2	2.0875	CW351H	CuNi9Sn2			
	CuPb10Sn	2.1176	CW352H		CuSn10Pb10	LB2	
	CuPb15Sn	2.1183	CC496K-GZ				
	CuPb1P	2.1160	CW113C	CuPb1P			
	CuPb20Sn	2.1189					
	CuSn10	2.1050.01	CC480K		CuSn10	CT1	
	CuSn10Zn	2.1087					
	CuSn12	2.1051.01	CC483K		CuSn12	PB2	
	CuSn14				CuSn14		
	CuSn4	2.1016	CW450K	CuSn4	CuSn4P	PB101	
	CuSn5			CW451K			
	CuSn6	2.1020	CW452K	CuSn6	CuSn6	PB103	
	CuSn6Zn6	2.1080					
	CuSn7						CuSn7
	CuSn7ZnPb	2.1090.03	CC493K-GZ				
	CuSn8	2.1030	CW453K	CuSn8	CuSn8P	PB104	
	CuZn10	2.0230	CW501L	CuZn10	CuZn10	CZ101	
	CuZn15	2.0240	CW502L	CuZn15	CuZn15	CZ102	
	CuZn20	2.0250	CW503L	CuZn20		CZ103	
	CuZn20Al2	2.0460	CW702R	CuZn20Al2	CuZn22Al2	CZ110	
	CuZn25Al15						
	CuZn28	2.0261	CW504L	CuZn28		CZ105	
	CuZn28Sn1	2.0470	CW706R	CuZn28Sn1	CuZn29Sn1		
	CuZn30	2.0265	CW505L	CuZn30	CuZn30	CZ106	
	CuZn30AlFeMn				CuZn30AlFeMn		
	CuZn31Si1	2.0490	CW708R	CuZn31Si1			
	CuZn33	2.0280	CW506L	CuZn33		CZ107	
	CuZn35Al1	2.0592.01	CC765S		CuZn30AlFeMn	HTB1	
CuZn35Ni2	2.0540	CW710R	CuZn35Ni2				
CuZn36	2.0335	CW507L	CuZn36	CuZn36	CZ108		
CuZn36Pb1.5	2.0331	CW601N	CuZn36Pb2	CuZn35Pb2	CZ131		
CuZn36Pb3	2.0375	CW602N	CuZn36Pb3	CuZn36Pb3	CZ124		
CuZn37	2.0321	CW508L	CuZn37	CuZn37	CZ108		
CuZn37Pb0.5	2.0332	CW604N	CuZn37Pb0.5		CZ118		
CuZn38Pb1.5	2.0371	CW607N	CuZn38Pb1.5	(CuZn38Pb2)	CZ119		
CuZn38Sn1	2.0530	CW717R	CuZn38Sn1				
CuZn38SnAl	2.0525	CW715R	CuZn38SnAl				
CuZn39AlFeMn							
CuZn39Pb0.5	2.0372	CW610N	CuZn39Pb0.5	CuZn39Pb0.8	CZ123		
CuZn39Pb2	2.0380	CW612N	CuZn39Pb2		CZ128		
CuZn39Pb3	2.0401	CW614N	CuZn39Pb3	CuZn39Pb3	CZ121		
CuZn40	2.0360	CW509	CuZn40	CuZn40	CZ109		
CuZn40Al2	2.0550	CW713R					

JIS	SS	UNS	AISI/ASTM	Misc. Brand	Condition	Form	Structure
		C60800					
C6140		C18400					
		C19400					
	5667	C70600					
		C79300					
		C76300					
C7451		C76300					
		C75200					
		C77000					
		C71300					
		C71580					
	5682	C70600					
		C70250					
		C72150					
		C72500					
	5640	C93700	CA937				
		C93800					
		C19000					
		C94100					
	5443	C90700					
	5458	C90500					
	5465		CA907				
	5475	C91000					
C5111		C51100					
		C51000					
C5191	5428	C51900					
		C93200					
		C83600					
C5210		C52100					
C2200		C22000					
C2300	5112	C23000					
C2400		C24000					
	5217	C68700					
		C86300					
C4430		C25600					
	5220	C44300					
C2600	5122	C26000					
C2680		C26800					
	5256	C96500	CA865				
C2720		C27200					
		C34200					
		C36000					
	5150	C27200					
		C33500					
	5165	C35300					
		C46400					
		C47000					
		C36500					
		C37700					
	5170	C38500					
C2800		C28000					
		C67410					

ISO	DIN	W.-Nr	EN	EN-Nr	AFNOR	BS	UNI
10	CuZn40Mn1	2.0572	CW723R	CuZn40Mn1			
	CuZn40Mn1Pb	2.0580	CW720R	CuZn40Mn1Pb			
	CuZn40Pb2	2.0402	CW612N	CuZn40Pb2	CuZn39Pb2		
	CuZn44Pb2	2.0410	CW622N	CuZn44Pb2			
	CuZn5	2.0220	CW500L	CuZn5		CZ136 CZ120 CZ104 CZ125	
11		1.4876	X2NiCrAlTi3220				
		2.4810	NiMo30				
		2.4810	NiMo30				
		2.4602					
		2.4819	NiMo16Cr15W				
		2.4610	NiMo16Cr16Ti				
	2.4619						
			NiCr21Fe18Mo9				
	2.4665						

JIS	SS	UNS	AISI/ASTM	Misc. Brand	Condition	Form	Structure
	5168	C37800					
	5272	C68700					
C2100		C21000					
				AMPCO15			
				AMPCO18			
				AMPCO18.136			
				AMPCO18.22			
				AMPCO18.23			
				AMPCO21			
				AMPCO22			
				AMPCO25			
				AMPCO26			
				AMPCO45			
				AMPCO483			
				AMPCO642			
				AMPCO673			
				AMPCO674			
				AMPCO8			
				AMPCO863			
				AMPCOM4			
		S66286		A286	precip.hardened		
		S35000		AM350		cast	
		S35000		AM350	heattreated		
		S35500		AM355			
		S45500		Custom455			
				Discalloy			
		N08800		Incoloy800			
				Incoloy801			
		N19909		Incoloy909			
				Lapelloy			
				M-308			
		R30155		N-155		bar,forge,ring	
		R30155		N-155			
				Air Resist13			
				FSX-414			
				H531			
				Haynes188		bar,forge,ring	
				Haynes188		tube	
				Haynes25			
				Mar-M-302			
				Mar-M-509			
		R30195		MP159			
				MP35N			
				Stellite21			
				Stellite30			
				Stellite31			
				W152			
				W162			
				Astroloy		allforms	
				GTD222			
		N10665		HastelloyB-2			
		N10002		HastelloyC		plate	
		N10002		HastelloyC		cast	
				HastelloyC-22			
		N10276		HastelloyC-276			
		N06455		HastelloyC-4			
		N06007		HastelloyG			
		N06985		HastelloyG-3			
		N10003		HastelloyN		bar,forge,ring	
		N10003		HastelloyN		cast	
		N06635		HastelloyS		allforms	
		N10004		HastelloyW			
		N06002		HastelloyX		allforms	

GENERAL TECHNICAL DATA

GENERAL TECHNICAL DATA

